

Operating Instructions

LCD Projector

Model No. **PT-L390U**

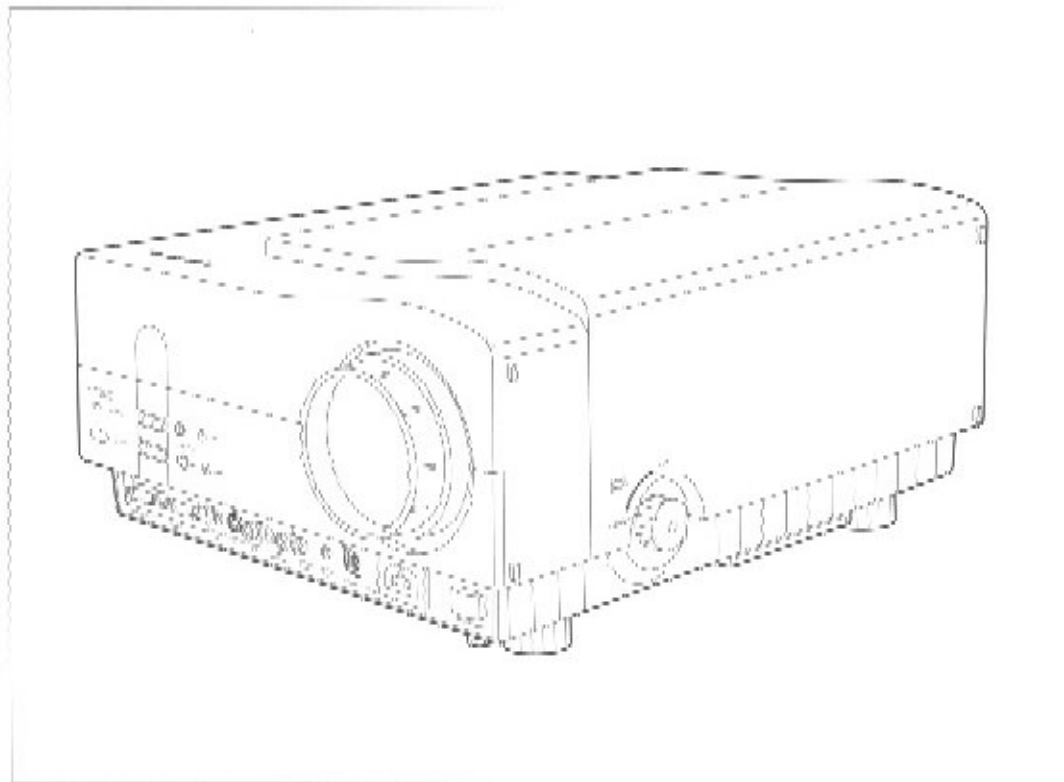

Panasonic[®]

Dear Panasonic Customer:

This instruction booklet provides all the necessary operating information that you might require. We hope it will help you to get the most performance out of your new product, and that you will be pleased with your Panasonic LCD Projector.

The serial number of your product may be found on its bottom. You should note it in the space provided below and retain this booklet in case service is required.

Model number PT-L390U Serial number _____

Trademark Acknowledgements

- PS/2 and VGA are trademarks of International Business Machines Corporation
 - Macintosh is a registered trademark of Apple Computer, Inc
 - PC-9801 is a trademark of NEC Corporation
 - VESA is a registered trademark of the Video Electronics Standards Association
- All other trademarks are the property of the various trademark owners.





Contents

IMPORTANT SAFETY NOTICE	2	Adjusting the picture position (POSITION)	25
Features	3	Adjusting the horizontal and vertical picture position (H-POS, V-POS)	25
Precautions with regard to safety	4	Horizontal and vertical blanking correction (H-BLK-L, H-BLK-R, V-BLK-U, V-BLK-L)	26
Precautions on handling	6	Adjusting the keystone of the picture border (KEY STONE)	27
Location and function of each projector part	7	Adjusting the clock phase (CLOCK PHASE)	28
Location and function of remote control unit parts	9	Turning off the on-screen display of input signal information (INPUT DISPLAY)	29
Before using the remote control unit	10	Disabling the power button of the remote control unit (REMOTE POWER)	29
Turning the power on and off	12	System configuration example	30
Screen requirements	14	Using the infrared mouse function	32
Standard setting-up positions	15	Using the RS-232C connector	33
Adjusting the height of the projected image	16	Indicators	39
Adjusting the projector horizon	16	Cleaning the air filter	40
Projection method (SETTING)	17	Lamp unit replacement period	41
Adjusting the picture size and focus	18	Replacing the lamp unit	41
Changing the input source	19	Before asking for service, check the following points	43
Controlling the sound	20	Specifications	44
Displaying the on-screen menus	20	External dimensions	46
Resetting adjustment values to the factory pre-settings (standard values)	20		
Switching the input signal mode (SIGNAL MODE)	21		
Selecting the picture mode (MODE)	23		
Adjusting the picture to the desired setting	24		

IMPORTANT SAFETY NOTICE

WARNING To prevent damage which may result in fire or shock hazard, do not expose this appliance to rain or moisture

Power Supply: This LCD Projector is designed to operate on 100 – 240 volts, 50/60 Hz, AC house current only

 <div data-bbox="332 413 553 520">CAUTION RISK OF ELECTRIC SHOCK DO NOT OPEN</div> 		<p>The lightning flash with arrowhead symbol, within an equilateral triangle, is intended to alert the user to the presence of uninsulated "dangerous voltage" within the product's enclosure that may be of sufficient magnitude to constitute a risk of electric shock to persons</p>
<p>CAUTION TO REDUCE THE RISK OF ELECTRIC SHOCK DO NOT REMOVE COVER (OR BACK) NO USER-SERVICEABLE PARTS INSIDE REFER SERVICING TO QUALIFIED SERVICE PERSONNEL</p>		<p>The exclamation point within an equilateral triangle is intended to alert the user to the presence of important operating and maintenance (servicing) instructions in the literature accompanying the product</p>

CAUTION: This equipment is equipped with a three-pin grounding-type power plug. Do not remove the grounding pin on the power plug. This plug will only fit a grounding-type power outlet. This is a safety feature. If you are unable to insert the plug into the outlet, contact an electrician. Do not defeat the purpose of the grounding plug.

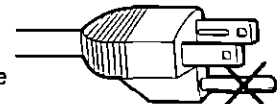

Do not remove

WARNING This equipment has been tested and found to comply with the limits for a Class A digital device, pursuant to Part 15 of the FCC Rules. These limits are designed to provide reasonable protection against harmful interference when the equipment is operated in a commercial environment. This equipment generates, uses, and can radiate radio frequency energy and, if not installed and used in accordance with the instruction manual, may cause harmful interference to radio communications. Operation of this equipment in a residential area is likely to cause harmful interference in which case the user will be required to correct the interference at his own expense.

CAUTION Any unauthorized changes or modifications to this equipment would void the users authority to operate

CAUTION The AC power cord which is supplied with the projector as an accessory can only be used for power supplies up to 125 V, 7 A. If you need to use higher voltages or currents than this, you will need to obtain a separate 250-V power cord. If you use the accessory cord in such situations, fire may result.

Features

Lightweight and compact body, with a high-luminance lamp unit that can produce up to 350 lm [ANSI]

A 1.3-inch polysilicon LCD panel contributes to a lighter and more compact body which weighs approximately 22.9 lbs (10.4 kg). And the high-luminance 350 lm [ANSI] lamp unit gives you added flexibility for a wide range of different types of business applications.

Data from personal computers (VGA or S-VGA^{*1}) can also be displayed

The projector can be connected directly to either a video signal source or to a VGA or S-VGA-compatible personal computer. The ability to connect to a large variety of different video signal sources gives the projector immense flexibility of use as a new-generation presentation tool.

*1 RGB signals with a horizontal resolution of greater than 640 dots or a vertical resolution of greater than 480 dots are converted to approx. 640 x 480 dot before they are projected.

Screens from 30 inches to 300 inches can be used

A manual-focus zoom lens which can project images onto screens ranging in size from 30 inches to 300 inches is provided as standard. In addition, a lens position adjustment function lets you adjust the vertical position of the projected image without having to tilt the projector.

An easy-to-use infrared mouse function can be used to control the on-screen pointer

The mouse cursor on the computer screen can be operated with ease by means of the remote control, which has a built-in infrared mouse function. As well as replacing the traditional hand-held pointer, this function also lets you control some simple personal computer functions.

Precautions with regard to safety

WARNING

Setting-up

Do not install this projector in a place which is not strong enough to take the projector's full weight

- If the installation location is not strong enough, the projector may fall down, which could cause severe injury and/or damage

Do not place the projector on top of surfaces which are sloped or unstable.

- The projector may fall down or tip over

During use, the ambient temperature of the place where the projector is being used should be between 41°F (5°C) and 104°F (40°C) and the humidity should be between 10% and 80%

- Do not set up the projector in places where there are extremely humid or dusty conditions, or in places where the projector may come into contact with smoke or steam. Using the projector under such conditions may result in fire or problems with operation

Do not carry out any installation work for the projector yourself.

- Allowing someone without the proper knowledge and training to install the projector is extremely hazardous, and can result in dangerous electric shocks or other injuries

Always disconnect the power cable before moving the projector

- Check that the power cable and any other cables are disconnected before moving the projector. Moving the projector with cables still attached can damage the cables, resulting in the possibility of fires and electric shocks

When using the projector

Do not make any modifications to the projector

- This can result in fire or electric shocks

Do not open the projector cover during use

- High voltages which can cause serious electric shocks are present inside the projector. Ask an Authorized Service Center to carry out inspection, adjustment and repairs

Do not do anything that might damage the power cable

- Do not damage the cable, make any modifications to it, place heavy objects on top of it, heat it, place it near any hot objects, twist it, bend it excessively or pull it. To do so may cause fires and electric shocks to occur. If the power cable becomes damaged, have it repaired at an Authorized Service Center or purchase a new cable

Do not stick any foreign objects into the projector

- Do not insert any metal objects or burnable objects into the ventilation holes or drop them onto the projector, as doing so can cause fire or electric shocks to occur

Do not spill water on the projector

- This can cause fire or electric shocks to occur

Do not cover the ventilation holes

- This can cause the inside of the projector to overheat, which may cause fire or problems with operation to occur

Do not use any type of power cable other than the one supplied with the projector.

- Use a cable with a three-pronged plug and do not defeat the ground, otherwise electric shocks may result

Do not handle the power cord plug with wet hands

- Doing so may cause electric shocks to occur

Do not bring your hand or other objects close to the air blower port

- Heated air comes out of the air blower port during projector operation. If you bring your hand and face or objects which cannot withstand heat close to the port during this time, you may receive a burn, or a fire may start

When disconnecting the power cable, hold the plug, not the cable

- If the power cable itself is pulled, the cable will become damaged, resulting in the possibility of fire or serious electric shocks

If problems occur during use

Do not use the projector if no image appears on the screen or no sound is heard.

- If a problem occurs, immediately turn off the power and disconnect the power cable from the wall outlet, otherwise continued use of the projector in this condition may cause fire or electric shocks to occur. Contact an Authorized Service Center.

Do not use the projector if you notice smoke or a strange smell coming from it.

- If an abnormality such as this occurs, turn off the power and disconnect the power cable from the wall outlet. Check that no more smoke is coming out, and then contact an Authorized Service Center for repairs. Do not attempt to repair the projector yourself, as this can be dangerous.

Do not use the projector if foreign objects or water get inside the projector, or if the projector is dropped or the cover is broken

- If something such as this occurs, turn off the power and disconnect the power cable from the wall outlet. Continued use of the projector in this condition may cause fire or electric shocks to occur.

CAUTION

When using the projector

Do not place any heavy objects on top of the projector.

- Doing so can cause the projector to become unbalanced and fall, which could result in damage and/or injury.

Do not look into the lens while the projector is being used

- Strong light is emitted from the projector's lens. If you look directly into this light, it can hurt and damage your eyes.

Fully insert the power cord plug into the wall outlet

- If the power cord plug is not fully inserted, the plug may become damaged from overheating, which could cause fires and electric shocks to occur.

Periodically inspect and clean the power cord plug

- If the power cord plug becomes dirty, the insulation may become damaged through increased humidity, which could cause fires or electric shocks to occur.

If not using the projector for long periods, disconnect the power plug from the wall outlet as a safety precaution

Cleaning and maintenance

Take particular care when replacing the lamp unit

- The metal halide lamp contains gas under high pressure. If it is dropped or hit against other objects, it may break, which could cause injury or problems with operation.

Ask an Authorized Service Center to clean inside the projector at least once a year

- If dust is left to build up inside the projector without being cleaned out, it can cause fire or problems with operation to occur. It is a good idea to clean the inside of the projector before the season for humid weather arrives. Ask your nearest Authorized Service Center to clean the projector when required. Consult your Authorized Service Center for details regarding cleaning costs.

Disconnect the power plug from the wall outlet as a safety precaution before carrying out any cleaning

- Electric shocks can result if this is not done.

Precautions on handling

Cautions regarding setting-up

Observe the following at all times when setting up the projector

- **Avoid setting up in places which are subject to vibration or shocks**
If the projector is set up in locations with strong vibration, such as near a motor, or if it is installed inside a vehicle or on board a ship, the projector may be subjected to vibration or shocks which can damage the internal parts and cause malfunctions or accidents. Accordingly, set up the projector in a place which is free from such vibrations and shocks
- **Do not set up the projector near high-voltage power lines or near motors**
The projector may be subject to electromagnetic interference if it is set up near high-voltage power lines or motors
- **Do not set up the projector directly on top of plastic sheet or carpet**
Plastic sheets can adhere to the air filter, which can cause the inside of the projector to overheat and the power supply to switch off
- **If installing the projector to the ceiling, ask a qualified technician to carry out all installation work**
If the projector is to be suspended from the ceiling, you will need to purchase the separate installation kit (Product No. ET-PK390L). Furthermore, all installation work should only be carried out by a qualified technician

Notes on use

- **In order to get the best picture quality**
If outside light or light from indoor lamps is shining onto the screen, the images projected will not have good contrast. Draw curtains or blinds over any windows, turn off any fluorescent lights near the screen and cover any highly-reflective floor and wall surfaces with carpet or wallpaper to prevent reflection
- **Do not touch the surfaces of the lens with your bare hands**
Do not touch the lens with your bare hands. If the surfaces of the lens becomes dirty from fingerprints or anything else, this will be magnified and projected onto the screen. Moreover, cover the lens with the accessory lens cap when not using the projector
- **About the screen**
If the screen you are using is dirty, damaged or discolored, attractive projections cannot be obtained. Do not apply any volatile substances to the screen, and do not let it become dirty or damaged

Before carrying out cleaning and maintenance, be sure to disconnect the power cord plug from the wall outlet.

Wipe the cabinet with a soft, dry cloth

If the cabinet is particularly dirty, soak the cloth in water with a small amount of neutral detergent in it, squeeze the cloth very well, and then wipe the cabinet. After cleaning, wipe the cabinet dry with a dry cloth. If using a chemically-treated cloth, read the instructions supplied with the cloth before use.

Do not wipe the lenses with a cloth that is dusty or which produces lint

If any dust or lint gets onto the lenses, such dust or lint will be magnified and projected onto the screen. Use the blower end of a vacuum cleaner to clean any dust and lint from the lens surfaces, or use a chamois cloth to wipe off any dust or lint.

Location and function of each projector part

<Front and right view>

Zoom ring (page 18)
This ring is used to adjust the size of the projection image

Focus ring (page 18)
This ring is used to adjust the image focus

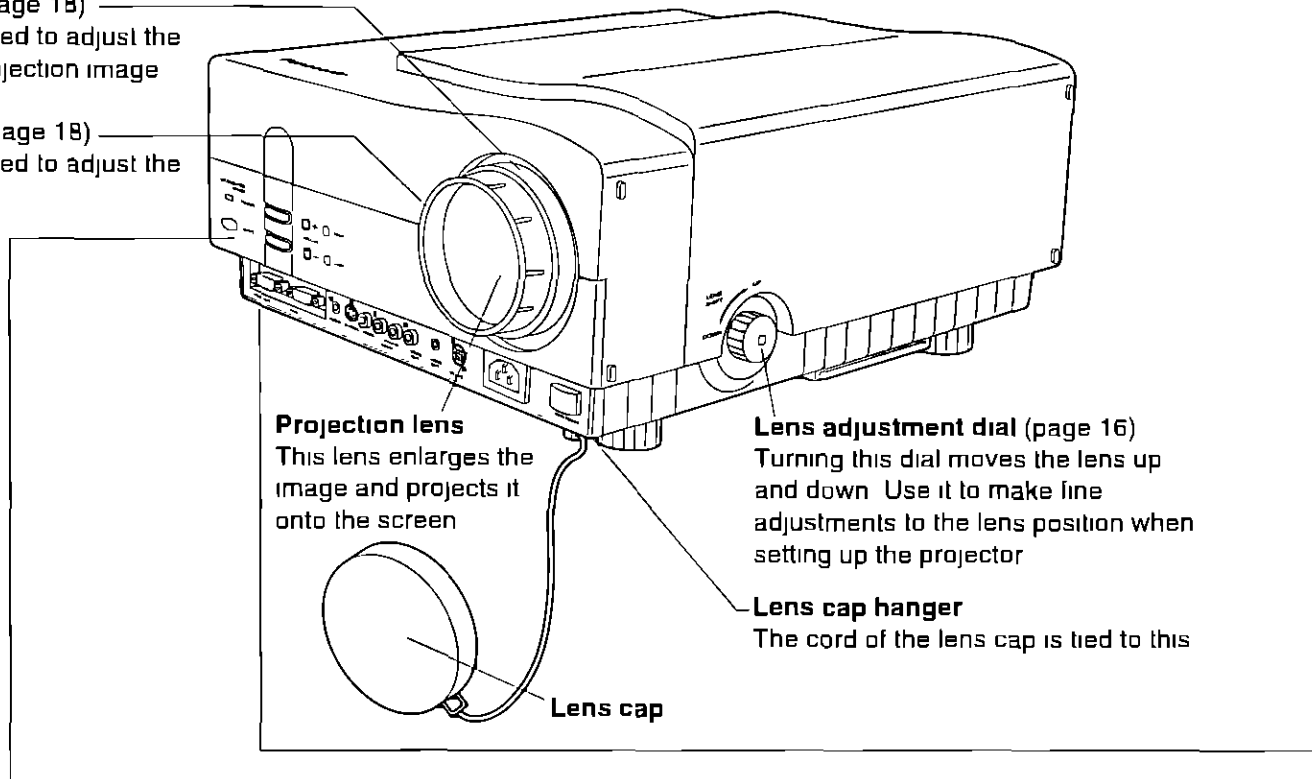

Projector control panel

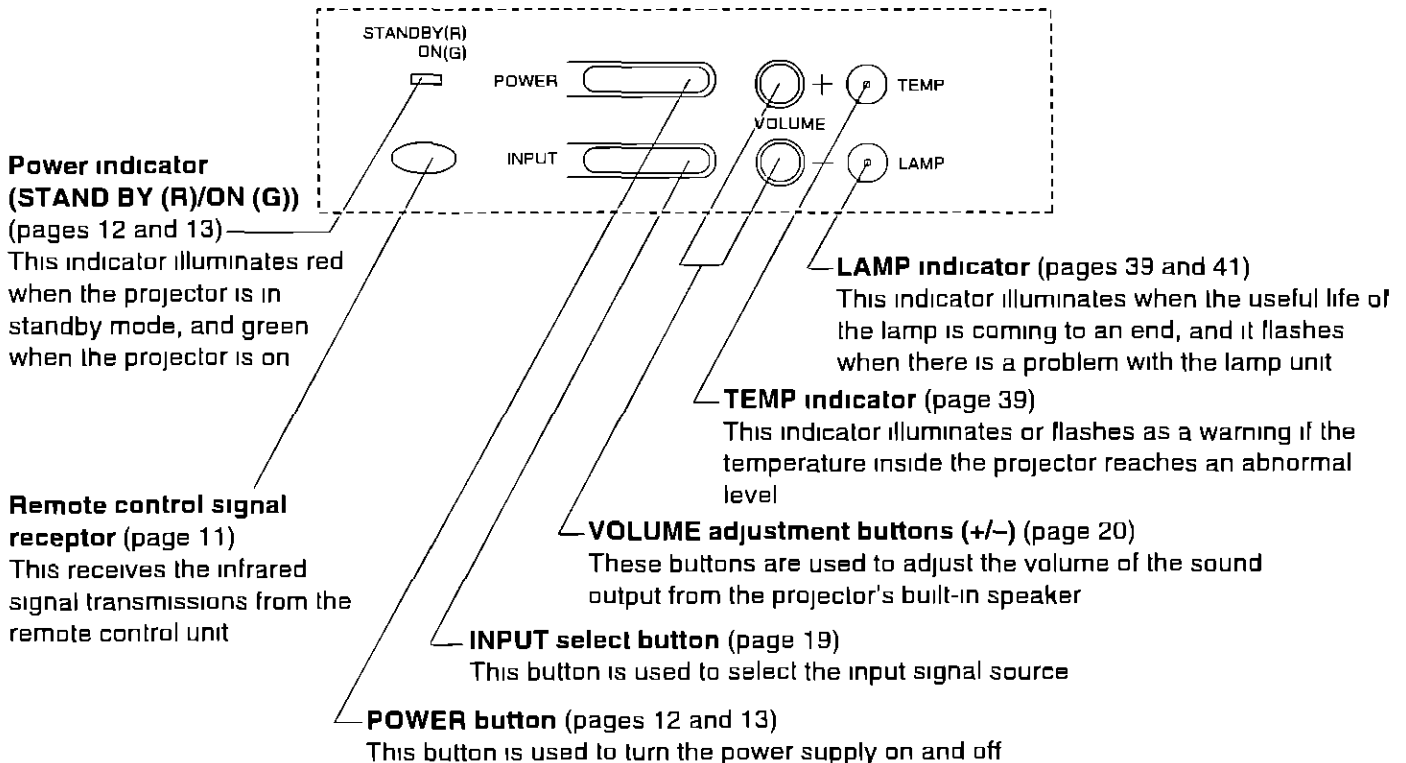

<Rear and left view>

Built-in speaker (page 20)
This is a built-in speaker which is capable of outputting monaural sound

Lamp unit cover fixing screw (page 42)
Remove this screw when replacing the lamp unit

Lamp unit cover (page 42)
Remove this cover to get access to the lamp unit

Adjustable legs (four) (page 16)
These legs can be used to adjust the angle of inclination of the projector

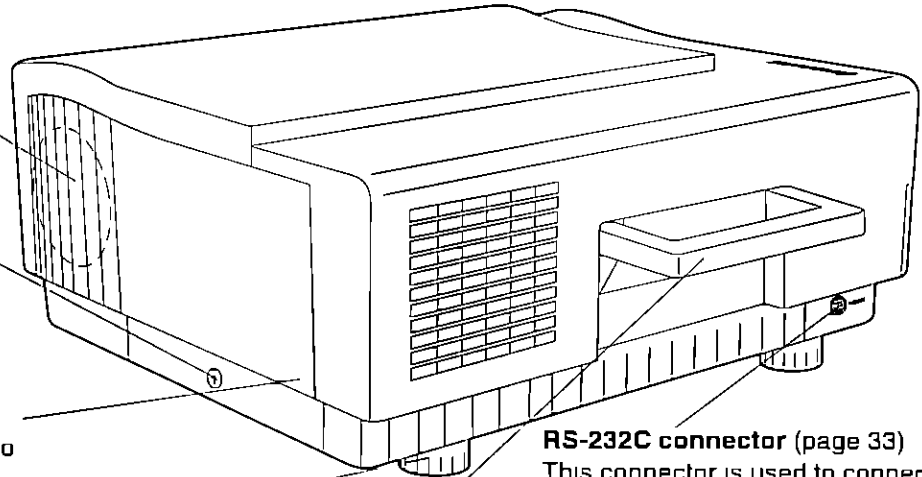

RS-232C connector (page 33)
This connector is used to connect a personal computer to the projector

Carrying handle
Pull out the handle and hold it when transporting the projector

Front connection panel

S-VIDEO IN terminal (page 31)
This terminal is used to input S-VIDEO signals

AUDIO IN terminal for RGB input (page 30)
This terminal is used to input audio signals which correspond to the signals input to the RGB IN connector

AUDIO IN (L-R) terminals for S-VIDEO/VIDEO input (page 31)
These terminals are used to input audio signals which correspond to the signals input to the VIDEO IN or S-VIDEO IN terminal

VIDEO OUT terminal (page 31)
This terminal is used to output video signals which are input to the projector

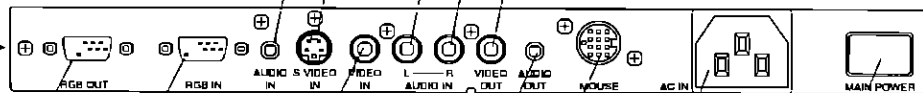

VIDEO IN terminal (page 31)
This terminal is used to input video signals

RGB IN connector (page 30)
This connector is used to input RGB signals

RGB OUT connector (page 30)
This connector is used to output RGB signals

MAIN POWER switch (pages 12 and 13)
This switch turns the power supply to the projector on and off

Power input socket (AC IN)
The power cord which is supplied with the projector is connected here

MOUSE connector (page 30)
This connector is used to connect the projector to a personal computer when using the infrared mouse function of the remote control unit

AUDIO OUT terminal (pages 30 and 31)
This terminal is used to output audio signals which are input from the AUDIO IN terminal for RGB input or the AUDIO IN (L-R) terminals for S-VIDEO/VIDEO input. The sound output is automatically switched when the audio input source is switched

Location and function of remote control unit parts

<Front view>

Arrow buttons (Up \wedge , Down \vee , Left \leftarrow , Right \rightarrow)

These buttons are used to select items from the menu screen and for changing setting values

MENU button (page 20)

This button is used to turn display of the menu screen on and off and to return display to the previous screen

MUTE button (page 20)

This button is used to temporarily turn off the sound

POWER button (pages 12 and 13)

This button is used to turn projection picture on and off

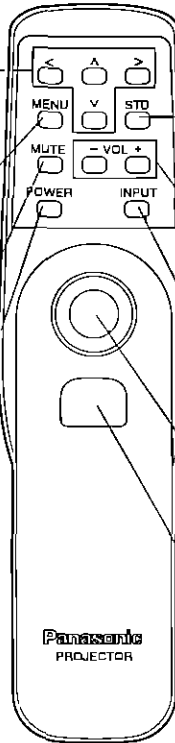

Standard (STD) button (page 20)

This button is used to reset the picture adjustment values to the factory pre-settings

Volume adjustment buttons (VOL +/-) (page 20)

These buttons are used to adjust the sound from the built-in speaker

INPUT select button (page 19)

This button is used to select the input signal source

Pointer button (page 32)

This can be used instead of a mouse pointing device to move the screen cursor

Click 2 button (page 32)

This button corresponds to the right button on a standard mouse with two buttons

<Side view>

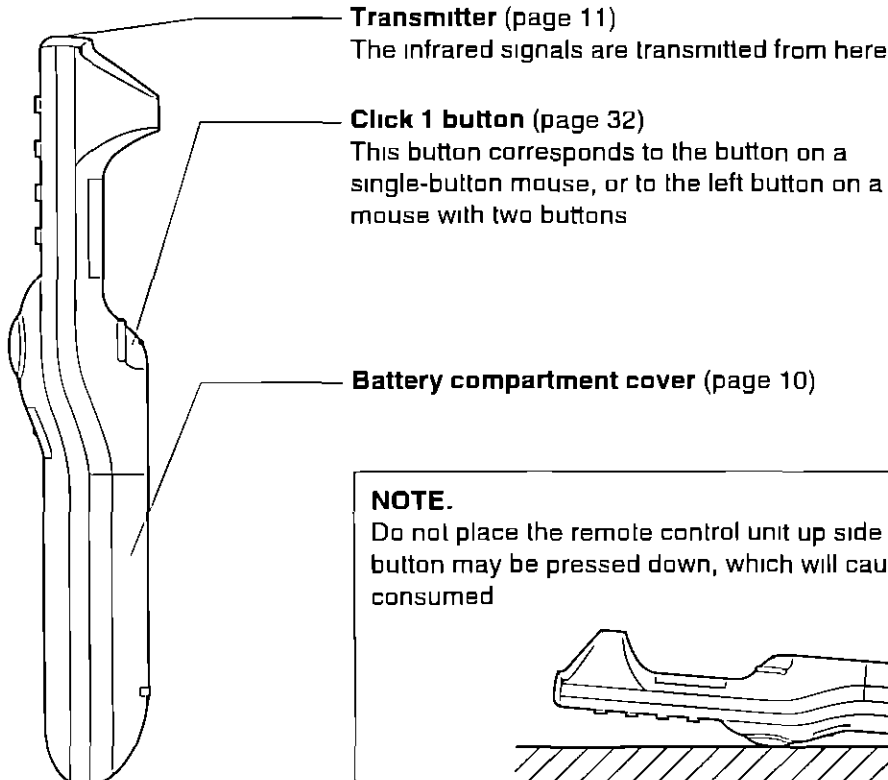

Transmitter (page 11)

The infrared signals are transmitted from here

Click 1 button (page 32)

This button corresponds to the button on a single-button mouse, or to the left button on a mouse with two buttons

Battery compartment cover (page 10)

NOTE.

Do not place the remote control unit up side down, otherwise the pointer button may be pressed down, which will cause the batteries to be consumed

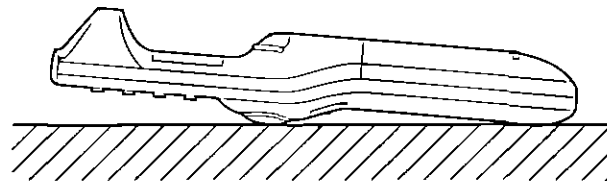

Before using the remote control unit

Inserting the batteries

Insert the AA batteries supplied with the remote control, making sure that the polarities are correct

Open the battery compartment cover.

Push the section with the  mark down firmly, and then pull the cover toward you to remove it

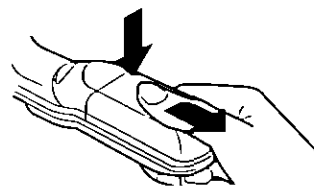

Insert the batteries.

Insert the batteries so that their direction matches the polarity markings inside the compartment

NOTE:

- Do not use rechargeable (Ni-Cd) batteries

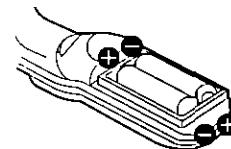

Close the battery compartment cover

Return the battery compartment cover to its original position

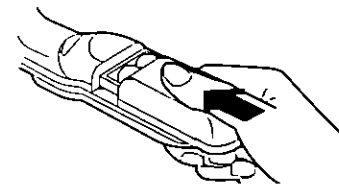

Notes on using the batteries

The following should be observed in order to prevent damage to or leaking of the batteries

Old Batteries

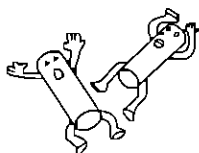

New Batteries



Replace both batteries at the same time
Furthermore, do not burn spent batteries or put them in with combustible garbage

Do not mix old and new batteries or batteries of different types (such as alkali and manganese batteries)

DO NOT do any of the following:

NG

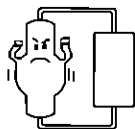

Do not recharge

NG

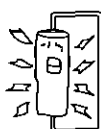

Do not short-circuit

NG

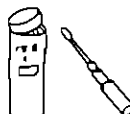

Do not disassemble

NG



Do not heat or burn

Operating range of the remote control unit

Point the remote control unit toward the remote control signal receptor on the projector. The operating range of the remote control unit is shown in the illustrations below

<Top view>

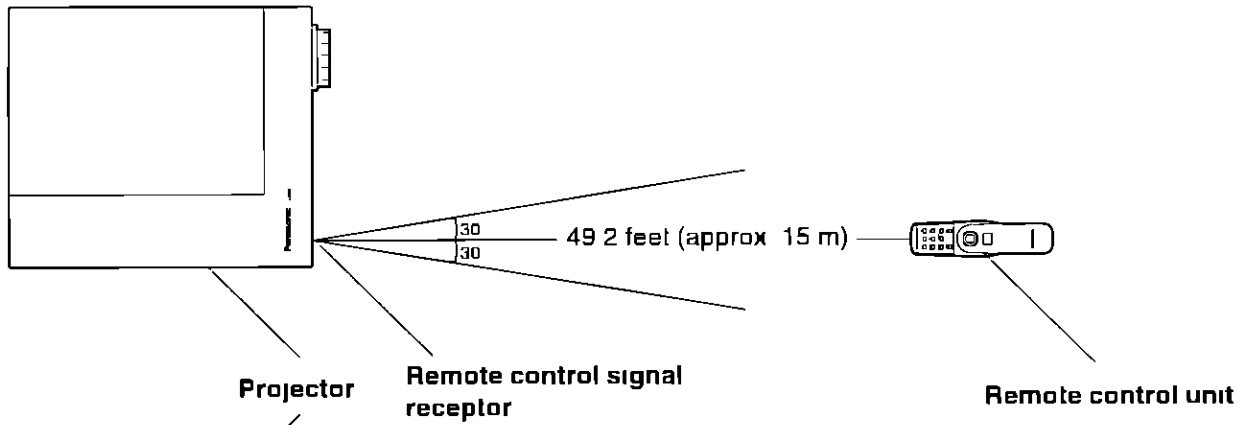

<Side view>

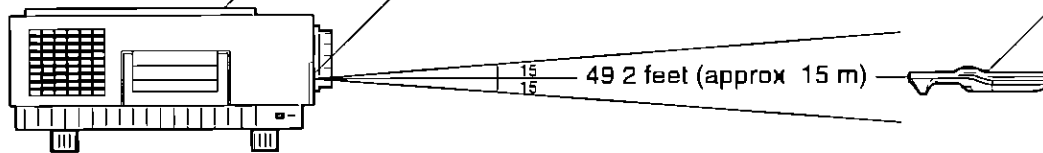

NOTE.

- To operate the projector, the remote control unit should be held in front of the remote control signal receptor within a distance of 49.2 feet (approximately 15 meters)
- If strong light is allowed to shine onto the remote control signal receptor, or if there are any obstacles between the remote control signal receptor and the remote control unit, correct remote control operation may not be possible

If facing the remote control unit toward the screen

The projector can also be operated by pointing the remote control unit toward the screen as shown in the illustration below

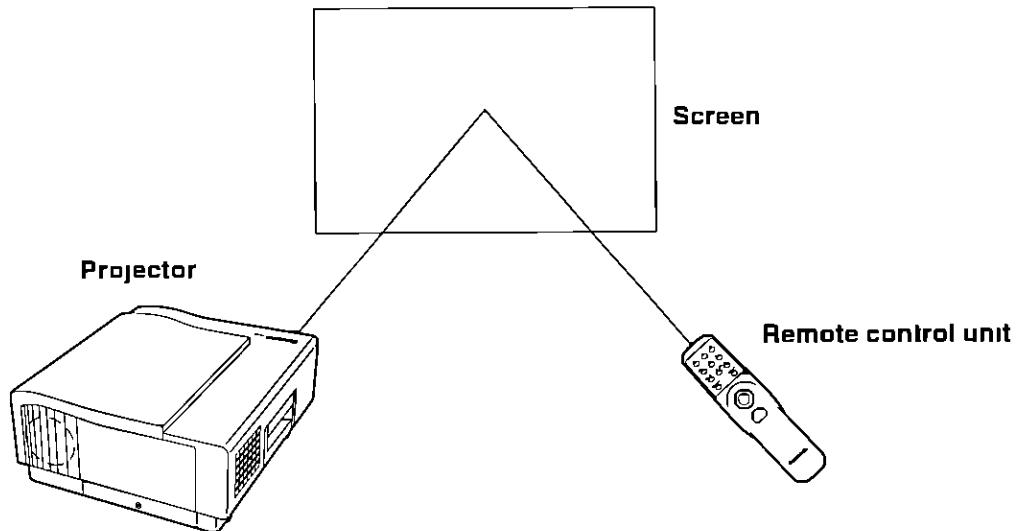

NOTE

- If facing the remote control unit toward the screen to operate the projector, the operating range of the remote control unit will be limited by the amount of light reflection loss caused by the characteristics of the screen used

Turning the power on and off

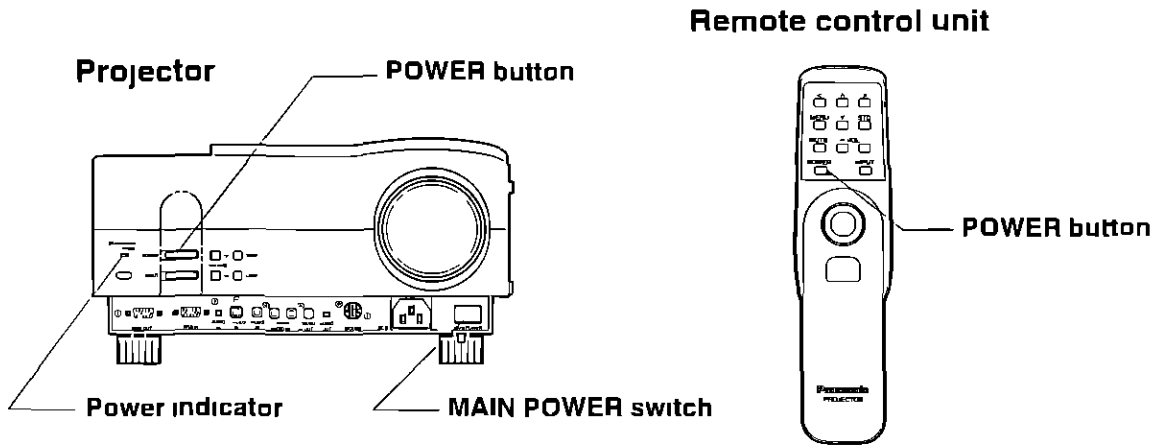

<Turn on the projector.>

① Turn on the MAIN POWER switch.

When the MAIN POWER switch is turned on, the power indicator will illuminate red and the projector will be in standby mode

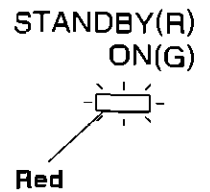
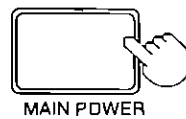

② Press the POWER button to turn on the projector lamp.

Approximately 15 seconds after the POWER button on either the projector or remote control unit is pressed, the power indicator will switch to green and the projector lamp will switch on

Projector

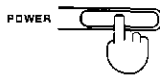

OR

Remote control unit

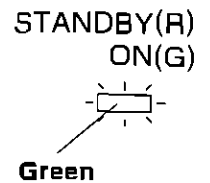

<Turn off the power after use.>

① Turn off the power.

While the metal halide lamp is on, press the POWER button on the remote control unit or on the projector control panel (Do not press the MAIN POWER switch immediately after turning off the lamp, otherwise it will shorten the lamp's operating life)

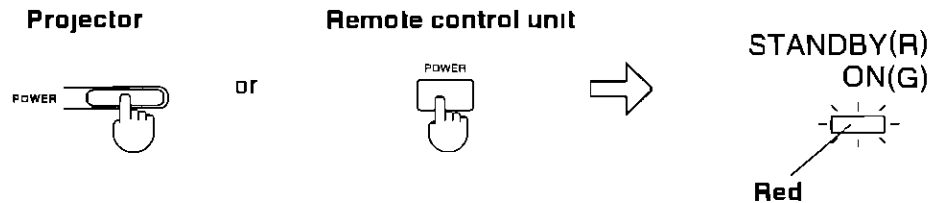

② Wait until the fan stops.

The metal halide lamp which is used as the light source is heated to high temperatures during use. Because of this, the fan keeps operating for approximately 90 seconds even after the MAIN POWER switch is pressed. Do not press the MAIN POWER switch until the fan stops operating.

③ Turn off the main power.

The power indicator will switch off.

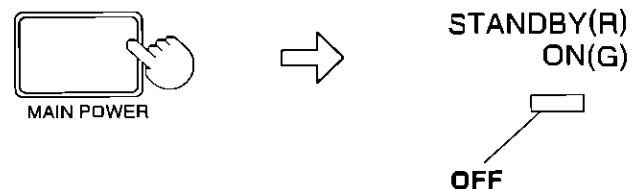

NOTE:

- If the remote power function has been set to off, the POWER button of the remote control unit will not work. Refer to page 29 for details on how to change the setting for this function.
- The cooling fan keeps operating while the temperature inside the projector remains high (usually for about 90 seconds) even after the lamp is turned off. Do not disconnect the power cord or turn off the main power until the cooling fan stops operating.
- If the power is turned off accidentally while the projector is operating, a picture will not be displayed again immediately after the power is turned back on again. Wait for a while until the lamp unit cools down before turning the power back on again.
- When the projector is in standby mode (when the lamp unit is off and the cooling fan has stopped), the projector continues to consume 10 W (for 100 – 120 V power supplies) or 17 W (for 220 – 240 V power supplies) of power.

Screen requirements

This projector is used to project the image onto flat screens. However, the brightness and viewable range will vary depending on which type of screen is used.

When selecting a screen, check the characteristics of the screen to ensure that it is suitable for the intended place of use.

Screen characteristics (reference)

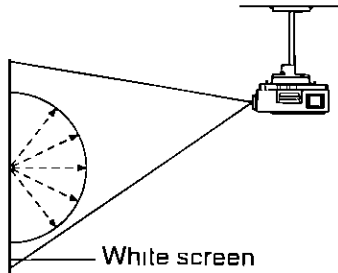
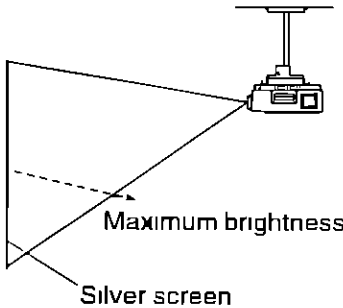
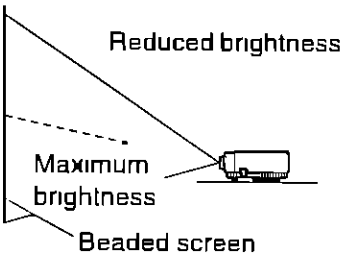
Screen type		Screen characteristics
Reflective screens	Polarized screen	Because the surface of the screen has been treated to make it polarized, it will only reflect light from a single direction. Consequently, if you use such a screen with an LCD projector, a clear image can be obtained even in bright rooms because the screen hardly reflects any extraneous light.
	White screen	This type of screen can be seen from anywhere, so there are no limits on the viewing position. However, the surrounding walls should be darkened as in a movie theater, otherwise a clear picture cannot be obtained.  White screen
	Silver screen	This type of screen gives a picture which is 2 - 4 times brighter than a white screen. A variety of types are available from different manufacturers, and each type has different brightness characteristics. Some also have restrictions on the possible range of viewing positions. <ul style="list-style-type: none"> ✗ Care should be taken with screens that have a high gain, as these types of screen can cause color distortion at the left and right edges. ✗ This type of screen is recommended when the projector is suspended from the ceiling.  Silver screen
	Beaded screen	This type of screen is similar to the silver screen, except that no color distortion occurs at the left and right edges. Moreover, most of the light is reflected at the same angle as the angle of incidence. <ul style="list-style-type: none"> ✗ This type of screen is recommended when the projector is placed on the floor.  Beaded screen
Translucent screens	Flexible translucent screen	This type of screen is made of PVC (polyvinyl chloride). It has the same characteristics as silver screens, but sometimes it can have hot spots.
	Rigid-type translucent screen	This type of screen is made of acrylic plastic. It is extremely durable and has excellent optical characteristics. It performs in the same way as silver screens.

Standard setting-up positions

After determining the appropriate position for the projector by referring to the illustrations and standard setting-up dimensions given below, set up the projector. The distance **L** from the projector to the screen and the height **H** do not vary, regardless of whether the projector is being used in the floor, ceiling, front or rear positions.

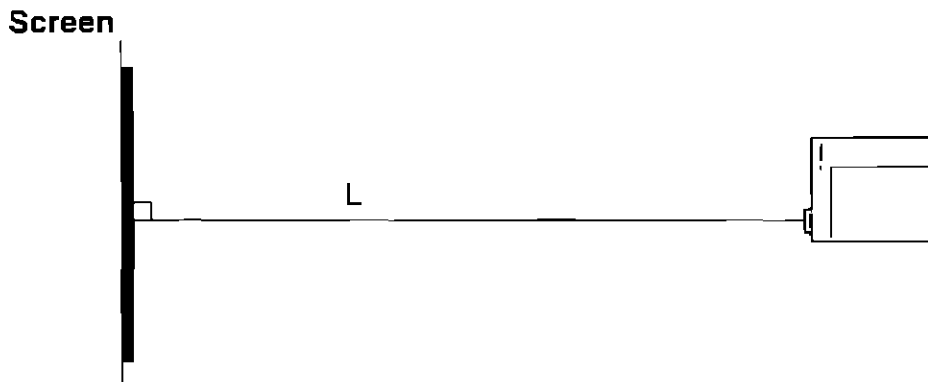
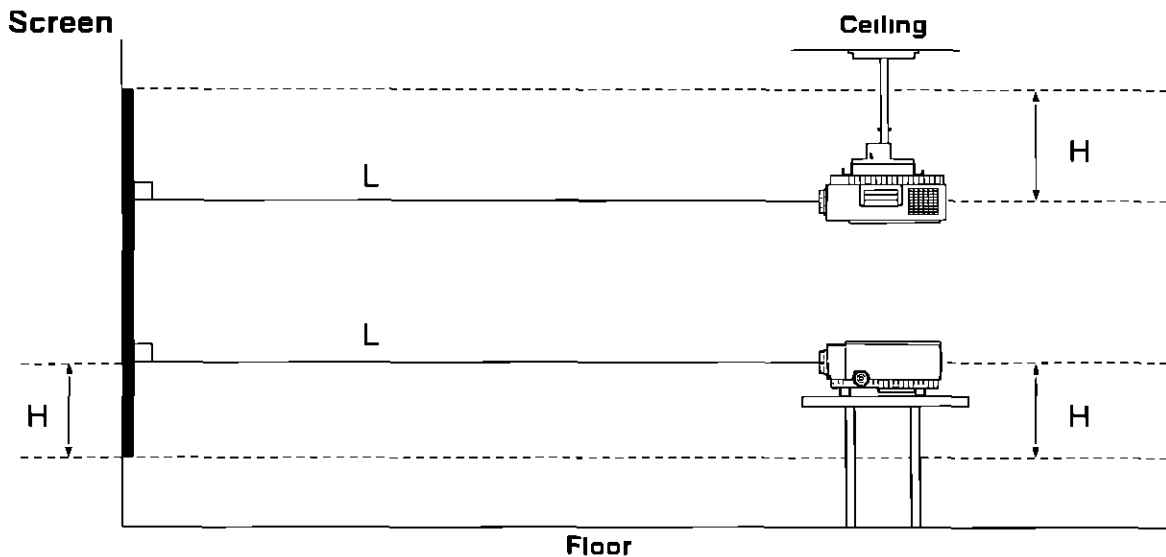

Standard setting-up dimensions

Because the projector uses a x1.4 zoom lens, it is possible to adjust the projection distance. And because there is also a function provided for adjusting the height of the lens, the height of the projector can also be adjusted relative to the position of the screen. For details, refer to pages 16 and 18.

Projection size	Projection distance (L)		Height from lower edge of screen to center of lens (H)
	Minimum	Maximum	
30	—	5'6" (1.7 m)	13 ¹ / ₃₂ " - 9 ¹ / ₃₂ " (5 - 23 cm)
40	5'3" (1.6 m)	7'6" (2.3 m)	22 ⁵ / ₃₂ " - 12 ³ / ₁₆ " (7 - 31 cm)
60	7'11" (2.4 m)	11'5" (3.5 m)	31 ⁵ / ₁₆ " - 1'6" (10 - 46 cm)
80	10'6" (3.2 m)	15'5" (4.7 m)	51 ¹ / ₈ " - 2' (13 - 61 cm)
100	13'6" (4.1 m)	19'4" (5.9 m)	65 ¹ / ₁₆ " - 2'52 ⁹ / ₃₂ " (16 - 76 cm)
150	20'1" (6.1 m)	29'2" (8.9 m)	91 ⁵ / ₃₂ " - 3'8 ⁷ / ₁₆ " (24 - 114 cm)
200	26'11" (8.2 m)	39' (11.9 m)	1'7 ¹ / ₃₂ " - 4'11 ³ / ₁₆ " (31 - 152 cm)
250	33'10" (10.3 m)	—	1'33 ³ / ₈ " - 6'22 ⁵ / ₃₂ " (39 - 190 cm)
300	40'9" (12.4 m)	—	1'61 ¹ / ₈ " - 7'5 ³ / ₄ " (46 - 228 cm)

NOTE

- In addition, if the projector is not completely vertical with respect to the screen and horizontal with respect to the floor, distortion of the projected image will result. Adjust the projector horizon by the procedure given on page 16.
- The values in the table shown above are approximate.

Adjusting the height of the projected image

The position of the projected image can be adjusted by changing the height of the projector lens using the lens adjustment dial

If the lens adjustment dial is turned clockwise, the position of the projected image will be raised

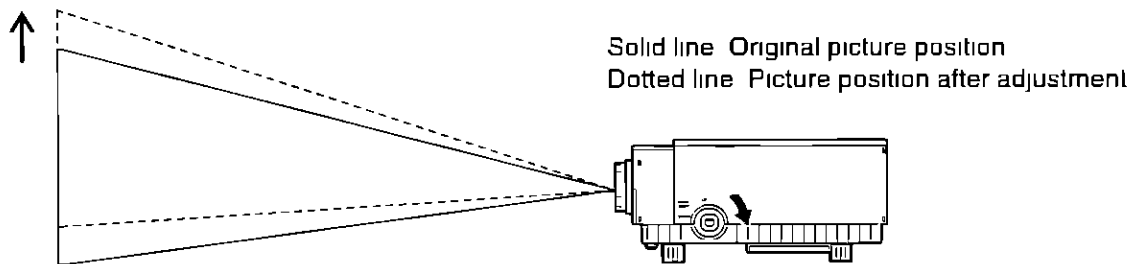

If the lens adjustment dial is turned counterclockwise, the position of the projected image will be lowered

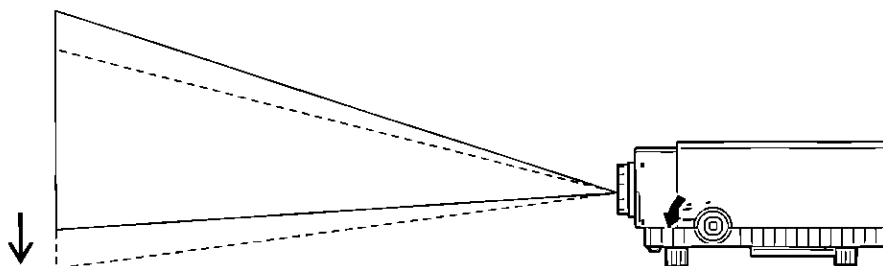

NOTE

- The possible range of adjustment will vary depending on the size of the projected image. For details, refer to "Standard setting-up positions" on page 15
- If the lens adjustment dial is turned too far, it will start to turn loosely

Adjusting the projector horizon

The height of each of the four legs on the base of the projector can be adjusted. If the place where the projector is being positioned is not perfectly level, adjust the heights of these legs so that the projector is stable and level.

NOTE

- Do not use the adjustable legs to change the angle of projection. If the projector is not perfectly vertical to the screen, distortion of the projected image will result.
- The legs can only be extended by $1\frac{3}{32}$ " (10 mm). If you try to extend them any further than this, they will merely spin freely.
- If you pull the legs while turning them, they may come completely loose from the projector. If this happens, replace the leg in its original position.

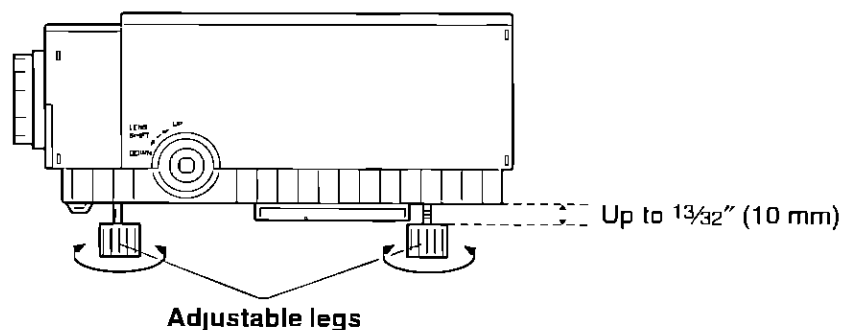

Projection method (SETTING)

The projection method can be changed in accordance with either one of the four setting-up methods A to D shown below. The projection method can be changed using the remote control unit. The projection method is set to method A at the time of shipment from the factory.

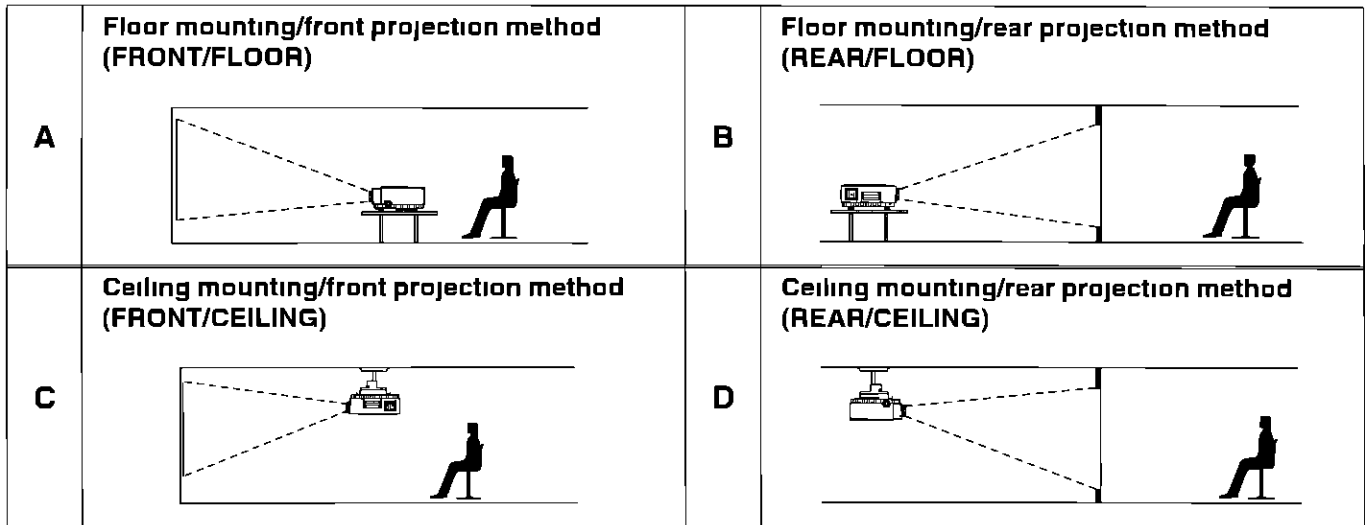

Changing the projection method

Use the following procedure to change the projection method.

<Operation procedure>

- ① Press the MENU button. The main menu will be displayed on the screen.
- ② Press the "▲" and "▼" buttons to move the cursor to the "SETTING" item.

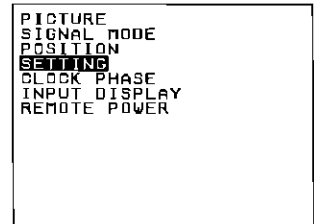

- ③ Press the ">" button. The projection method setting menu screen will be displayed.
- ④ Press the "▲" and "▼" buttons to select the desired projection method.

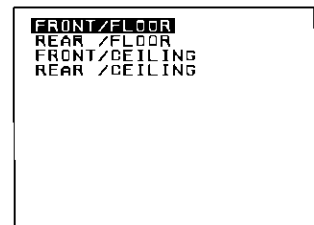

NOTE:

- The adjustment screen and the main menu screen can both be cleared by pressing the MENU button.

Adjusting the picture size and focus

After setting-up the projector at the correct distance from the screen in accordance with the required projection size (refer to page 15), adjust the picture size and focus while looking at the image projected onto the screen

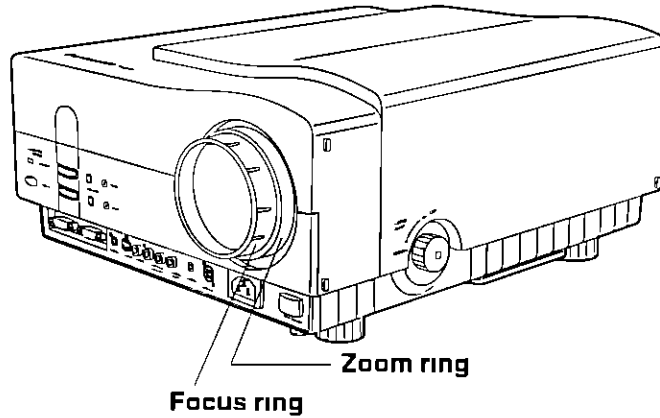

① Adjust the picture size.

Turn the zoom ring to adjust the picture size

NOTE

- If the zoom ring is turned clockwise, the picture size becomes larger, and if it is turned counterclockwise, the picture size becomes smaller

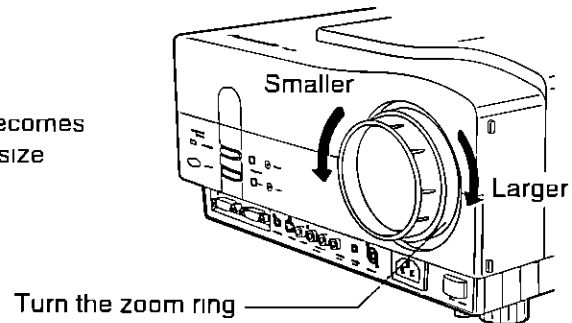

② Adjust the focus.

Turn the focus ring to the position where the picture on the screen is at its sharpest

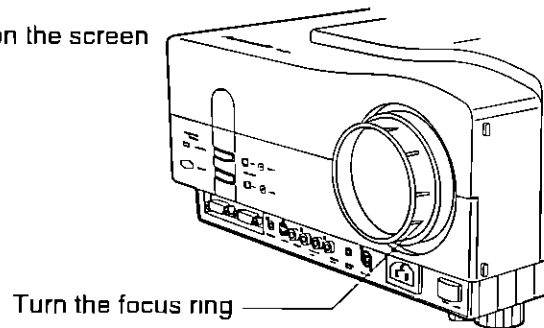

③ Adjust the picture size once more.

The picture size will change when the focus ring is turned, so you should adjust the picture size once more

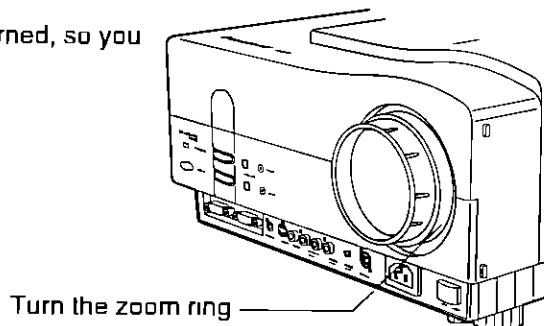

Changing the input source

Projector

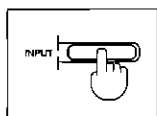

Remote control unit

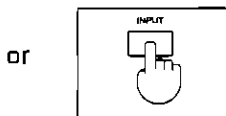

The input signal source changes as shown below each time the INPUT select button on the remote control unit or projector control panel is pressed

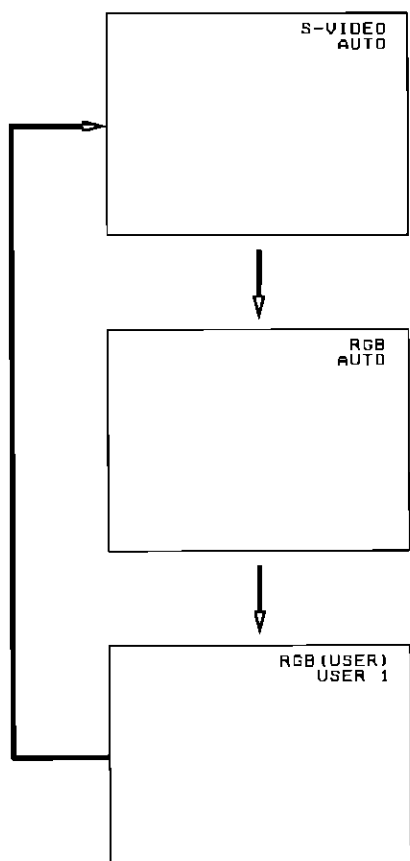

The video signal from the input signal source which is connected to the S-VIDEO IN or VIDEO IN terminal will be projected
At this time, the audio input will be switched to the signal from the input source which is connected to the AUDIO IN (L-R) terminals for S-VIDEO/VIDEO input. However, only one audio signal input system is available, so if you wish to change the audio input source, you will need to remove and insert the appropriate plugs

A finely-adjusted picture will be projected, together with the input signal which corresponds to the RGB signal which is being input to the RGB IN connector and which was selected according to the procedure on pages 21–22
The audio signal input will be switched to the signals being input to the AUDIO IN terminal for RGB input

An adjusted picture will be projected, together with the input signal which corresponds to the RGB signal which is being input to the RGB IN connector and which the user selected in RGB (USER) mode. For details on the methods of selection and adjustment, refer to page 22
The audio signal input will be switched to the signals being input to the AUDIO IN terminal for RGB input

NOTE

- If the S-VIDEO IN and VIDEO IN terminals are both connected at the same time, the S-VIDEO IN signal input will automatically be given priority. If you wish to view the signal being input to the VIDEO IN terminal, disconnect the plug from the S-VIDEO terminal
- Refer to page 21 for details on the types of computer signal data which can be input to the RGB IN connector
- RGB signals with a horizontal resolution of greater than 640 dots or a vertical resolution of greater than 480 dots are converted to approx 640 x 480 dot before they are projected
- The mode name for the currently-selected signal or the name of the signal format will be displayed at the bottom of the on-screen display
- The input selection on-screen display normally appears when projection starts, and also when the input source is being switched. However, if the input display setting (INPUT DISPLAY) has been turned off, this on-screen display will not appear

Controlling the sound

The volume of the sound from the built-in speaker can be controlled from the projector operation panel and also from the remote control unit

Adjusting the volume

Press the VOLUME adjustment buttons on the remote control unit or on the projector operation panel. The current volume will be displayed on the screen by means of numerals and a bar

Projector

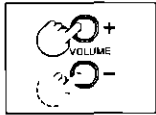

Remote control unit

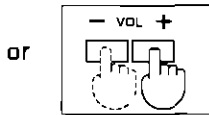

or



- + button Volume increases
(Maximum setting is 63)
- button Volume decreases
(Minimum setting is 0)

NOTE:

- The volume setting will not appear on the screen while other on-screen displays such as the main menu are being displayed

Turning off the sound

Press the MUTE button on the remote control unit. The on-screen display shown below will appear and the sound will be turned off

If the MUTE button is pressed once more, the sound will be restored

Remote control unit

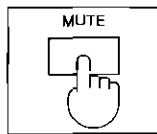

NOTE

- The sound will also be restored if a VOLUME adjustment button is pressed or if the power is turned off and then back on again
- The mute setting will not appear on the screen while other on-screen displays such as the main menu are being displayed

Displaying the on-screen menus

The on-screen menu display will appear on the screen when the MENU button is pressed

Remote control unit

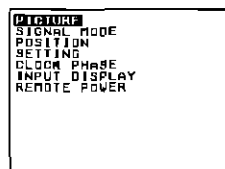
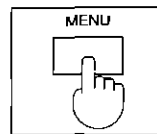

- Press when there is no on-screen display. The on-screen menu shown at left will be displayed

NOTE

- If the MENU button is pressed while an on-screen menu display is already on the screen, the display will switch to the previous screen and the screen shown at left will be cleared

Resetting adjustment values to the factory pre-settings (standard values)

If the STD (standard) button on the remote control unit is pressed while the cursor is at the MODE position in the PICTURE adjustment menu or while the POSITION adjustment menu or one of the individual adjustment screens is being displayed, the adjustment settings being displayed will be reset to the factory pre-settings

Remote control unit

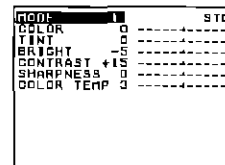
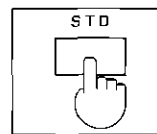

- If the STD (standard) button is pressed while the cursor is at the MODE position in the PICTURE adjustment menu
All items in the PICTURE adjustment menu will be reset to the factory pre-settings, and the letters "STD" will appear in the top-right corner of the screen
- If the STD (standard) button is pressed while the POSITION adjustment menu is being displayed
All items in the POSITION adjustment menu will be reset to the factory pre-settings (However, the letters "STD" will not appear on the screen)
- If the STD (standard) button is pressed while one of the individual adjustment screens is being displayed
Only the items being displayed will be reset to the factory pre-settings

Switching the input signal mode (SIGNAL MODE)

If a normal picture cannot be obtained after changing the input signal source, you will need to switch to SIGNAL MODE and then select and make fine adjustments to the input signal
 In SIGNAL MODE, setting data has been pre-recorded separately for S-VIDEO (or VIDEO) signals and for RGB signals. The procedure for displaying the setting screen for each respective input signal selection mode is described below.

Preparation

- ① Press the MENU button to display the menu screen
- ② Press the "▲" and "▼" buttons to select "SIGNAL MODE"
- ③ Press the "▶" button to determine the adjustment mode. The signal mode screen will be displayed.
 The items that can be adjusted will vary depending on the type of signal being input. Please refer to the descriptions below.

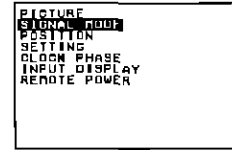

Selecting the input mode for S-VIDEO and VIDEO

The screen shown at right will be displayed. The signal system format can then be changed.
 The signal mode should basically be set to "AUTO". If the screen does not display properly when a signal is input from a dubbed video, change this setting to NTSC or PAL. Select the system format using the "▲" and "▼" button.

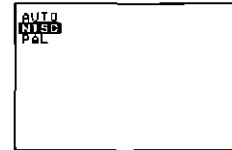

Format	Data
AUTO	The setting is switched to either NTSC or PAL in accordance with the input signal.
NTSC	Horizontal scanning frequency is set to 15.75 kHz and vertical scanning frequency is set to 59.94 Hz.
PAL	Horizontal scanning frequency is set to 15.63 kHz and vertical scanning frequency is set to 50.00 Hz.

NOTE

- If approximately five seconds pass without any buttons being pressed, the currently-displayed adjustment menu screen will be cleared and the setting function will be canceled.

Setting the RGB input signal selection mode

The picture setting changes each time the cursor is moved to a different display mode name using the "▲" and "▼" buttons. Switch the display mode to the display mode listed in the "Table of recorded signal data" below which matches the input signal or which is closest to it. If necessary, carry out further adjustments by referring to "Making fine adjustments to the dot clock frequency" on the following page.

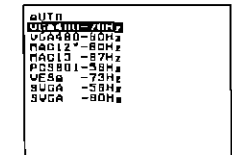

NOTE

- If the mode is set to "AUTO", the mode which corresponds to the input signal will automatically be selected from the available pre-recorded modes.
- The mode is set to "AUTO" before shipment from the factory.

- Table of recorded signal data

Display mode name	No. of dots	Horizontal scanning frequency (kHz)	Vertical scanning frequency (Hz)
VGA 400-70Hz	640 × 400	31.5 kHz	70 Hz
VGA 480-60Hz	640 × 480	31.5 kHz	60 Hz
MAC 12"-60Hz	512 × 384	24.5 kHz	60 Hz
MAC 13"-67Hz	640 × 480	35.0 kHz	67 Hz
PC9801-56Hz	640 × 400	24.5 kHz	56 Hz
VESA-73Hz	640 × 480	37.9 kHz	72 Hz
SVGA-56Hz	800 × 600	35.2 kHz	56 Hz
SVGA-60Hz	800 × 600	37.9 kHz	60 Hz

Setting the RGB (USER) input signal selection mode

This mode is necessary for selection and adjustment of the input signal to suit any peripheral equipment which you may have connected to the projector

Carry out selection and adjustment while referring to "Selecting a signal in RGB (USER) mode" and "Making fine adjustments to the dot clock frequency" below

<Selecting a signal in RGB (USER) mode>

Use the "▲" and "▼" buttons to select either "USER 1" or "USER 2". The "USER 1" or "USER 2" signal from the connected equipment can then be registered.

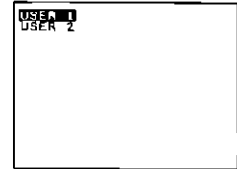

NOTE

- Both the "USER 1" and "USER 2" settings are only valid when an RGB signal with a display resolution of 640 x 480 dots is being input.

<Making fine adjustments to the dot clock frequency>

If the RGB picture signal which was selected in input signal selection mode (SIGNAL MODE) is not projected normally, you will need to make fine adjustments to the dot clock frequency. Adjust by the following procedure while viewing the picture.

- This adjustment procedure should be carried out only after selecting the closest signal to the input signal in RGB input signal selection mode and after selecting "USER 1" or "USER 2" in RGB (USER) mode.

- Press the ">" button continuously for 3 seconds or more. The dot clock frequency adjustment screen will be displayed.
- Press the ">" and "<" buttons to adjust the frequency. The setting level range is -15 to +30.

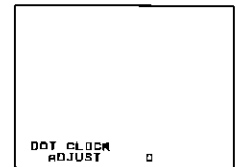

NOTE:

- If approximately five seconds pass without any buttons being pressed, the dot clock frequency adjustment menu screen will be cleared and the setting function will be canceled.
- The adjustment screen and the main menu screen can both be cleared by pressing the MENU button.

Selecting the picture mode (MODE)

In order to obtain the best picture, the projector has three different picture and color adjustment settings which have been preset, one for each of the VIDEO/S-VIDEO (NTSC), VIDEO/S-VIDEO (PAL) and RGB input signals. The input signal settings can be switched between these three modes (MODE 1 – 3) by the following procedure

Operating procedure

- ① Press the MENU button. The main menu will be displayed on the screen.
- ② Press the "▲" and "▼" buttons to move the cursor to the "PICTURE" item.

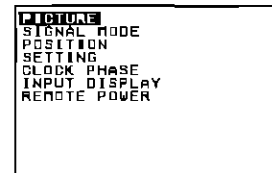

- ③ Press the ">" button. The picture adjustment menu screen will be displayed.
- ④ Press the "▲" and "▼" buttons to move the cursor to the "MODE" item.
- ⑤ Press the ">" button to select "MODE 1", "MODE 2" or "MODE 3".
 - Select the desired setting in accordance with the set-up environment and the video software being used.

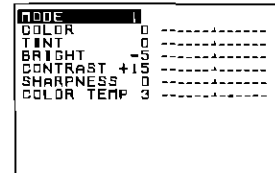

- MODE 1 Select this setting when using the projector in a place with standard brightness. The picture will be displayed at standard settings.
- MODE 2 Select this setting when using the projector in a bright place. A well-modulated picture with good contrast will be displayed.
- MODE 3 Select this setting when using the projector in a dark place. A good picture can be obtained even if there is some noise in the input signal.

NOTE

- The adjustment screen and the main menu screen can both be cleared by pressing the MENU button.
- Picture adjustments can be made to any of the modes which are selected by the above procedure, and these adjustments can be saved. For details, refer to page 24.
- If the STD (standard) button is pressed while the cursor is at the MODE position in the PICTURE adjustment menu, all of the PICTURE adjustment menu items will be reset to the factory pre-settings, and the letters "STD" will appear in the top-right corner of the screen.

Displaying items which cannot be selected

The items which can be selected from each menu will vary depending on the type of input signal which has been selected. Items which cannot be selected from a particular on-screen menu will be shown in white. If any such items appear in the current menu, the words "WHITE CAN'T ADJUST" will appear at the bottom of the screen.

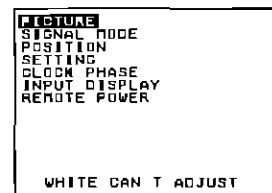

Adjusting the picture to the desired setting

You can make the desired setting adjustments separately for each video signal mode (MODE 1 – 3). The items which cannot be adjusted will vary for each mode.

Example Adjusting the COLOR setting

① Press the "▲" and "▼" buttons to move the cursor to "COLOR"

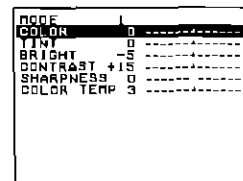

② Adjust using the "<" and ">" buttons. When the "<" and ">" buttons are pressed, the individual adjustment screens will be displayed and the currently-displayed item can be adjusted. The current setting will be displayed on the screen by means of numerals and a bar.

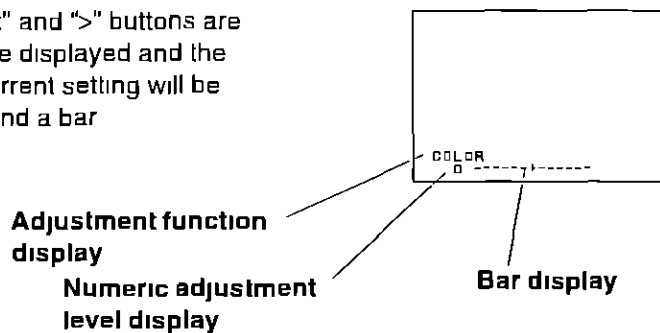

Adjustment Item	Adjustment Direction and Adjustment Details		Remarks
COLOR	▼	The color becomes darker (Max value +20)	S-VIDEO/VIDEO only
	▲	The color becomes lighter (Min value -20)	
TINT	▼	Flesh tones become greenish (Max value +20)	NTSC (S-VIDEO/VIDEO) only
	▲	Flesh tones become reddish (Min value -20)	
BRIGHT	▼	The screen becomes brighter (Max value +10)	
	▲	The screen becomes darker (Min value -10)	
CONTRAST	▼	The screen becomes brighter and the picture becomes darker (Max value +15)	
	▲	The screen becomes darker and the picture becomes lighter (Min value -15)	
SHARPNESS	▼	The picture quality becomes sharper (Max value +15)	S-VIDEO/VIDEO only
	▲	The picture quality becomes softer (Min value -15)	
COLOR TEMP	▼	The picture becomes tinged with blue (Max value 5)	
	▲	The picture becomes tinged with red (Min value 1)	

NOTE

- Items in a menu which cannot be adjusted appear in white and cannot be selected.
- While adjusting the setting in an individual adjustment screen, the display color for the setting value will change when the value is changed to the factory setting level (standard value).
- If approximately five seconds pass without any buttons being pressed, the currently-displayed adjustment screen will be cleared and the setting function will be canceled.
- The adjustment screen and the main menu screen can both be cleared by pressing the MENU button.
- If the STD (standard) button is pressed while one of the individual adjustment screens is being displayed, only the items being displayed will be reset to the factory pre-settings.

Adjusting the picture position (POSITION)

After setting up the projector and the screen so that they are correctly positioned relative to each other, check the position and display area of the picture on the screen. If they are incorrect, select "POSITION" from the main menu and then carry out the following adjustments.

Adjusting the horizontal and vertical picture position (H-POS, V-POS)

The position of the picture on the screen can be moved horizontally and vertically. If adjustment is necessary, carry out the following procedure.

Example: To adjust the horizontal position (H-POS)

Adjustment procedure

- ① Press the MENU button. The main menu screen will be displayed.
- ② Press the "▲" and "▼" buttons to move the cursor to "POSITION".

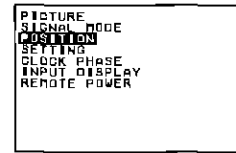

- ③ Press the ">" button. The picture position adjustment menu screen will be displayed.

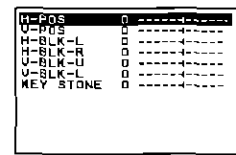

NOTE

- If the STD (standard) button is pressed while the POSITION adjustment menu at right is being displayed, all items in the POSITION adjustment menu will be reset to the factory pre-settings.

- ④ Press the "▲" and "▼" buttons to move the cursor to "H-POS".
 - To adjust the vertical position of the picture, select "V-POS" instead.

- ⑤ Press the "<" and ">" buttons to adjust the picture position. The H-POS adjustment screen will appear and the adjustment condition will be displayed.

Numeric adjustment level display

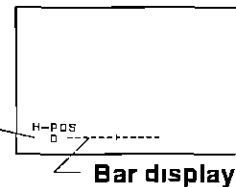

When adjusting the horizontal position (H-POS)

(Adjustment range 0 - 40)

If the ">" button is pressed, the picture moves to the right.

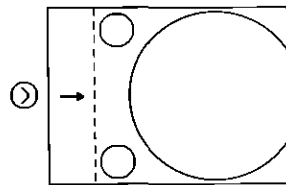

If the "<" button is pressed, the picture moves to the left.

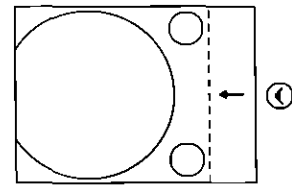

When adjusting the vertical position (V-POS)

(Adjustment range 0 - 40) However, if PAL signals are being input, the adjustment level range is 0 - 14, and if RGB signals with a display resolution of other than 640 x 480 dots are being input, the setting can be switched between 0 and 1 only.

If the ">" button is pressed, the picture moves up.

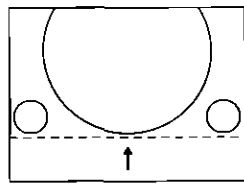

If the "<" button is pressed, the picture moves down.

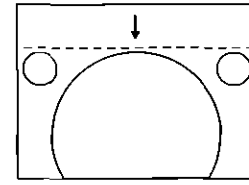

NOTE

- If approximately five seconds pass without any buttons being pressed, the currently-displayed adjustment menu screen will be cleared and the setting function will be canceled.
- While adjusting the setting in an individual adjustment screen, the display color for the setting value will change when the value is changed to the factory setting level (standard value).
- The adjustment screen and the main menu screen can both be cleared by pressing the MENU button.

Horizontal and vertical blanking correction (H-BLK-L, H-BLK-R, V-BLK-U, V-BLK-L)

The picture area can be adjusted by means of blanking correction. If adjustment is necessary, carry out the following procedure.

Adjustment procedure (for blanking correction of the left side of the screen)

The procedure below starts from the picture position adjustment menu screen.

H-POS	0	----- -----
U-POS	0	----- -----
H-BLK-L	0	----- -----
H-BLK-R	0	----- -----
U-BLK-U	0	----- -----
V-BLK-L	0	----- -----
KEY STONE	0	----- -----

- Press the “^” and “v” buttons to move the cursor to “H-BLK-L”.
 - To carry out blanking correction of the right side of the screen, select “H-BLK-R”, for the top, select “V-BLK-U”, for the bottom, select “V-BLK-L”.

- Press the “<” and “>” buttons to adjust the setting.

(Adjustment range 0 – 40
However, if RGB signals with a display resolution of other than 640 × 480 dots are being input, the setting can be switched between 0 and 1 only)

When the “<” and “>” buttons are pressed, the individual H-BLK-L adjustment screen will be displayed and the setting can be adjusted. The current setting will be displayed on the screen by means of numerals and a bar.

Numeric adjustment level display

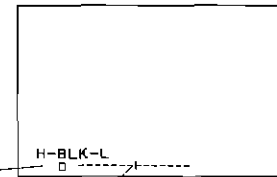

Bar display

Left-side blanking correction (for the H-BLK-L screen)

When the “>” key is pressed, the blanking edge will move to the right and the picture area will become narrower.

When the “<” key is pressed, the blanking edge will move to the left and the picture area will become wider.

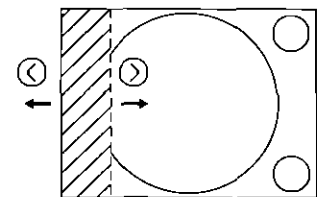

Right-side blanking correction (for the H-BLK-R screen)

When the “>” key is pressed, the blanking edge will move to the right and the picture area will become wider.

When the “<” key is pressed, the blanking edge will move to the left and the picture area will become narrower.

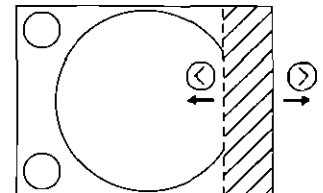

Top blanking correction (for the V-BLK-U screen)

When the “>” key is pressed, the blanking edge will move up and the picture area will become wider.

When the “<” key is pressed, the blanking edge will move down and the picture area will become narrower.

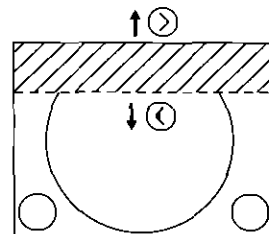

Bottom blanking correction (for the V-BLK-L screen)

When the “>” key is pressed, the blanking edge will move up and the picture area will become narrower.

When the “<” key is pressed, the blanking edge will move down and the picture area will become wider.

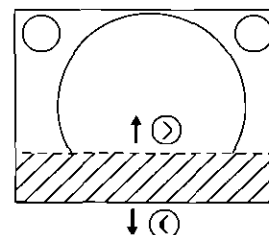

NOTE:

- If approximately five seconds pass without any buttons being pressed, the currently-displayed adjustment menu screen will be cleared and the setting function will be canceled.
- While adjusting the setting in an individual adjustment screen, the display color for the setting value will change when the value is changed to the factory setting level (standard value).
- The adjustment screen and the main menu screen can both be cleared by pressing the MENU button.

Adjusting the vertical angle of the picture border (KEY STONE)

If the projection angle between the projector and the screen is not correct, keystone distortion of the projected image will result. This distortion can be adjusted by the following procedure.

Note, however, that if you try to solve this problem by enlarging the picture and blanking the edges, the distortion will still persist.

Adjustment procedure

The procedure below starts from the picture position adjustment menu screen.

① Press the "▲" and "▼" buttons to move the cursor to "KEYSTONE"

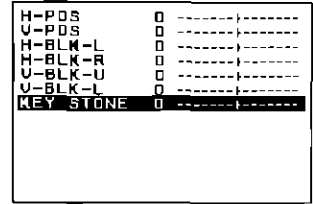

② Press the "<" and ">" buttons to adjust the keystone. (The adjustment level range is -20 to +20.)

When the "<" and ">" buttons are pressed, the individual keystone adjustment screen will be displayed and the setting can be adjusted. The current setting will be displayed on the screen by means of numerals and a bar.

Numeric adjustment level display

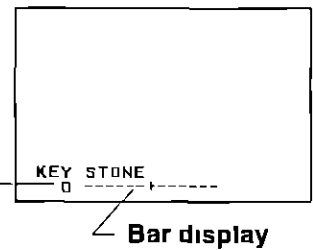

- **If the lower part of the screen is too wide and is distorted**

Press the ">" button to adjust so that the vertical sides of the picture borders are vertical. If the borders move too far in, press the "<" button to move them back toward their original positions.

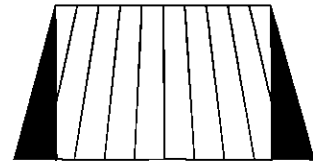

- **If the upper part of the screen is too wide and is distorted**

Press the "<" button to adjust so that the vertical sides of the picture borders are vertical. If the borders move too far in, press the ">" button to move them back toward their original positions.

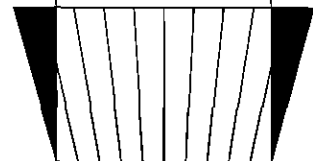

NOTE-

- If approximately five seconds pass without any buttons being pressed, the keystone adjustment screen will be cleared and the setting function will be canceled.
- While adjusting the setting in an individual adjustment screen, the display color for the setting value will change when the value is changed to the factory setting level (standard value).
- The adjustment screen and the main menu screen can both be cleared by pressing the MENU button.

Adjusting the clock phase (CLOCK PHASE)

If "CLOCK PHASE" is selected from the main menu screen, you can eliminate the flicker (localized noise) that appears on the computer screens when RGB signals are input. Carry out the following procedure if this adjustment is necessary.

Adjustment procedure

- ① Press the MENU button. The main menu screen will be displayed.
- ② Press the "▲" and "▼" buttons to move the cursor to "CLOCK PHASE".

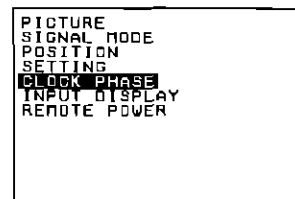

- ③ Press the ">" button. The clock phase adjustment screen will appear and the current setting will be displayed.

- ④ Press the "<" and ">" buttons to adjust until the screen noise is eliminated.

Numeric adjustment
level display

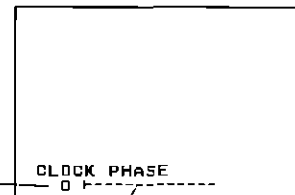

Bar display

NOTE.

- If approximately five seconds pass without any buttons being pressed, the clock phase adjustment screen will be cleared and the setting function will be canceled.
- While adjusting the setting in an individual adjustment screen, the display color for the setting value will change when the value is changed to the factory setting level (standard value).
- The adjustment screen and the main menu screen can both be cleared by pressing the MENU button.

Turning off the on-screen display of input signal information (INPUT DISPLAY)

When the INPUT SELECT button is pressed to change the input source, the names of the input signals and the input signal modes will be appear on the screen. You can stop this on-screen display from appearing by the following procedure

Operation procedure

- ① Press the MENU button The main menu screen will be displayed
- ② Press the "▲" and "▼" buttons to move the cursor to "INPUT DISPLAY"

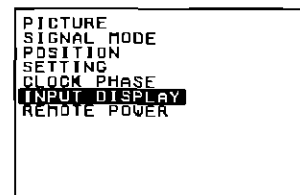

- ③ Press the ">" button The input display setting screen will be displayed
- ④ If the cursor is moved to "OFF" using the "▲" and "▼" buttons, the input signal display function will be turned off and the name of the input signal will no longer be displayed

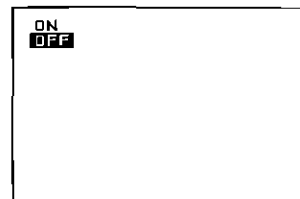

NOTE.

- If the cursor is moved to "ON" in the input display setting screen, the input signal display function will be turned on and the name of the input signal will be displayed as normal
- The adjustment screen and the main menu screen can both be cleared by pressing the MENU button

Disabling the power button of the remote control unit (REMOTE POWER)

The power button on the remote control unit can be disabled to prevent the chance of mis-operation when using the remote control unit

Operation procedure

- ① Press the MENU button The main menu screen will be displayed
- ② Press the "▲" and "▼" buttons to move the cursor to "REMOTE POWER"

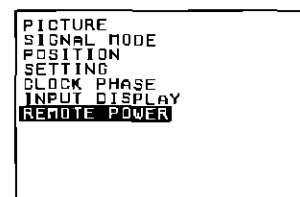

- ③ Press the ">" button The remote power setting screen will be displayed
- ④ If the cursor is moved to "OFF" using the "▲" and "▼" buttons, only the POWER button on the remote control unit will be disabled

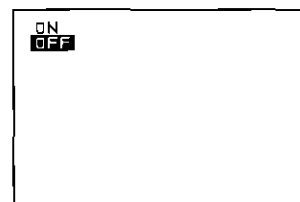

NOTE

- If the cursor is moved to "ON" in the remote power setting screen, the POWER button on the remote control unit can be used to turn the power on and off
- The adjustment screen and the main menu screen can both be cleared by pressing the MENU button

System configuration example

Notes on system configuration

- Turn off the power supply of each system component before connecting any of the components
- Read the instruction manual for each system component before connecting it
- If the necessary cables for connecting any system components are not supplied with the component or available as an option, you may need to fashion a cable to suit the component concerned
- If there is a lot of jitter in the video signal input from the video source, the picture on the screen may flicker. In such cases, it will be necessary to connect a TBC (time base collector)
- The projector can be connected to video signal sources which output VIDEO, S-VIDEO and analog RGB signals (0.8 – 5.0 Vp-p synchronized signals)
- The projector has a built-in speaker. However, you will need to connect a separate audio system to the AUDIO OUT terminal if your needs specify high sound volumes. No sound will come out of the projector's built-in speaker while the AUDIO OUT terminal is being used.

Example of connection to a computer

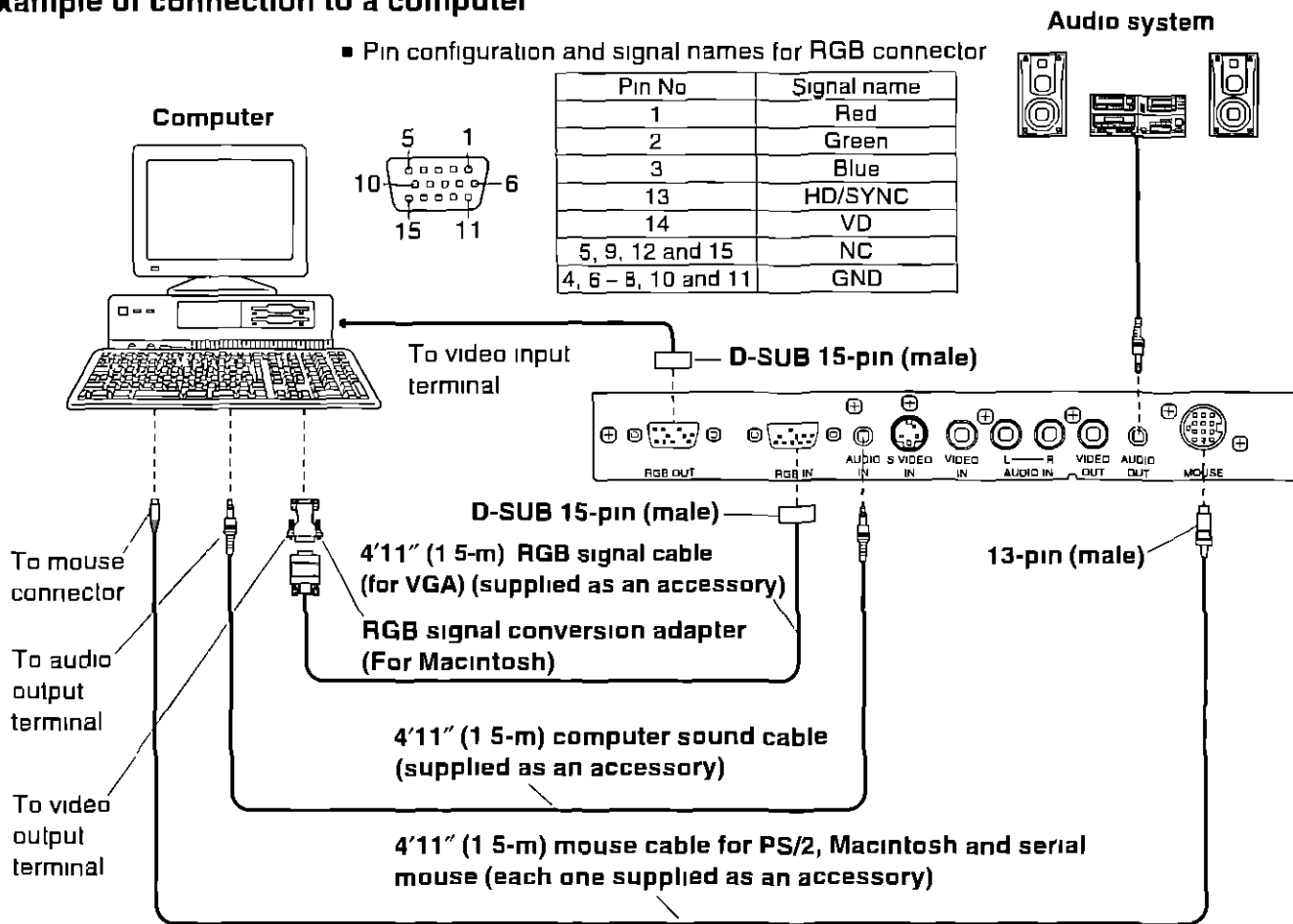

NOTE

- If the mouse connector on the projector is connected to the mouse connector on the computer with the accessory mouse cable, you can then use the remote control unit in place of the computer's mouse. For further details, refer to page 32.
- If you wish to use the infrared mouse function, turn on the main power to the projector before turning on the personal computer.
- Sometimes the infrared mouse function may not operate after the main power supply for the projector is turned on and off. To avoid this, turn off the personal computer also when turning off the projector.
- If using a personal computer with a suspend/resume function, the infrared mouse function may not operate until the computer is restarted.
- Refer to the data on page 21 for details of what kinds of computers can be connected to the projector. If computers other than those listed here are used, correct operation cannot be guaranteed.

Example of connection to audio-visual equipment

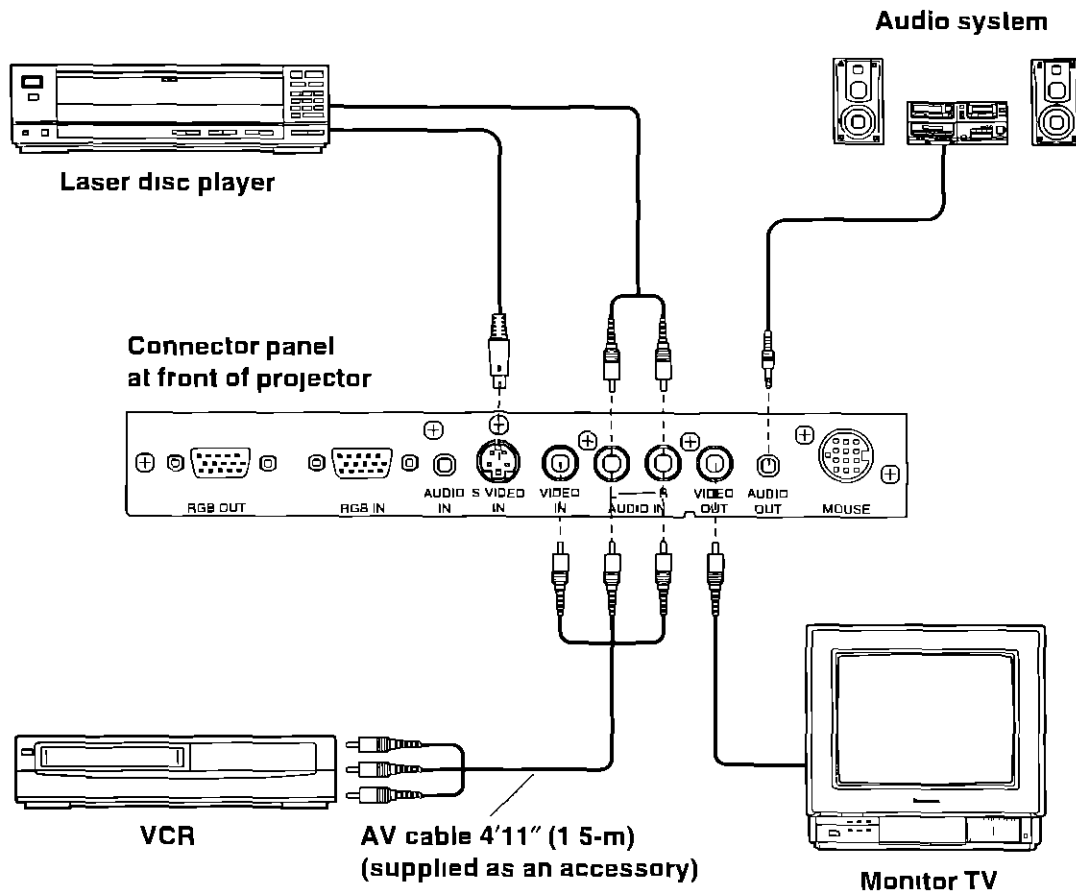

NOTE:

- If the S-VIDEO IN and VIDEO IN terminals are both connected at the same time, the S-VIDEO IN signal input will have priority. If you wish to view the signal being input to the VIDEO IN terminal, disconnect the plug from the S-VIDEO IN terminal.
- S-VIDEO signals cannot be output from the VIDEO OUT terminal.
- When the input source has been switched to RGB signals, the signals from the source which is connected to the VIDEO IN terminal will be output from the VIDEO OUT terminal.
- Only one audio signal input system is available for the AUDIO IN (L-R) terminals for S-VIDEO/VIDEO signals, so if you wish to change the audio input source, you will need to remove and insert the appropriate plugs.
- If the video signal source is connected using a cable with a BNC junction plug, use the accessory BNC/RCA adapter to convert the pin jack.

Using the infrared mouse function

The accessory remote control unit is provided with an infrared mouse function. By connecting the projector with your personal computer, the remote control unit can be used to move the cursor on the screen and to make and cancel selections instead of the computer's mouse. However, computers other than PS/2, Macintosh or serial-type computers cannot be used in this way.

Preparation

Connect the personal computer to the projector using an appropriate mouse cable as shown in the illustration below.

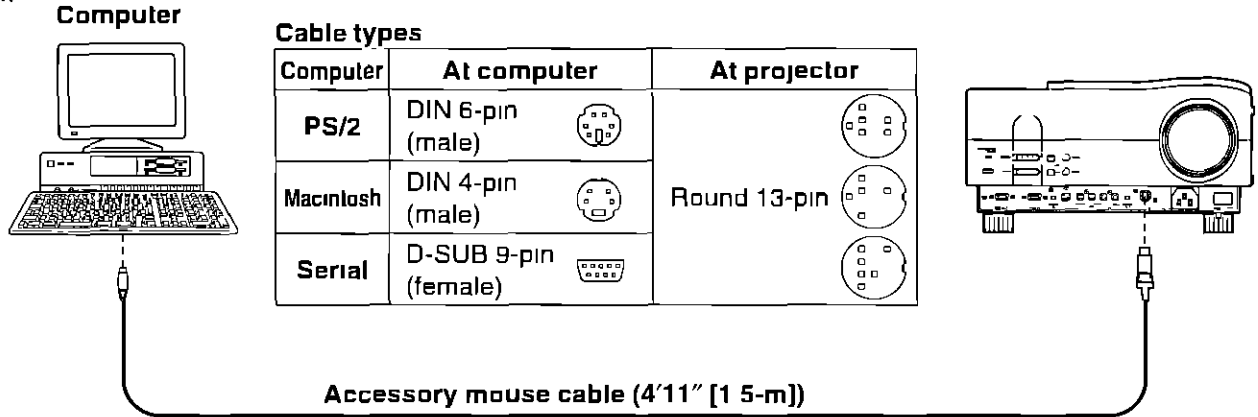

NOTE:

- When using the infrared mouse function, be sure to use the mouse cable which is supplied as an accessory. If any other cable is used, the infrared mouse function will not operate and this unit or the personal computer may be damaged.

Operation

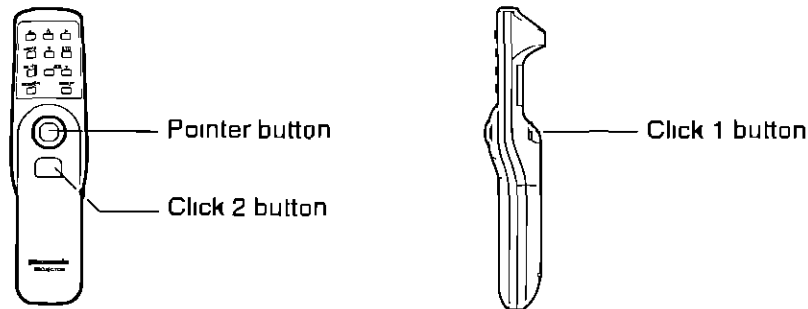

Pointer button

While gently pressing the pointer button with your thumb, push the pointer button back and forward and to the left and right. The cursor (arrow) will move back and forward and to the left and right on the screen.

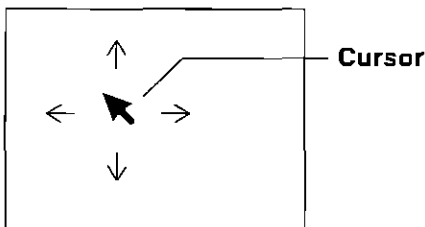

Click 1 button

This button corresponds to the button on a single-button mouse, or to the left button on a mouse with two buttons.

Click 2 button

This button corresponds to the right button on a standard mouse with two buttons.

Using the RS-232C connector

If the projector is connected to a personal computer by means of an RS-232C-compatible cable, the computer can be used to control the projector and to check the condition of the projector

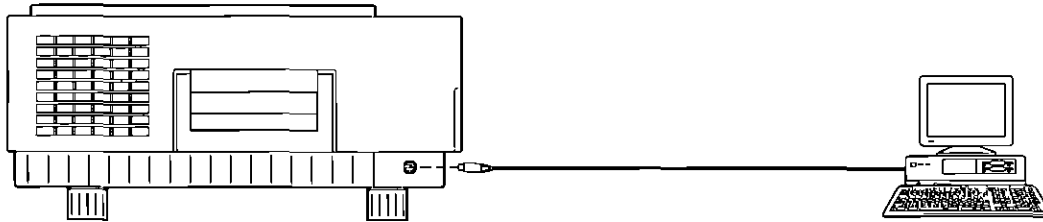

NOTE.

- Check that the pin layouts of the connectors on both ends of the RS-232C connection cable match the connectors on the projector and on the computer

1. Pin configuration and signal names

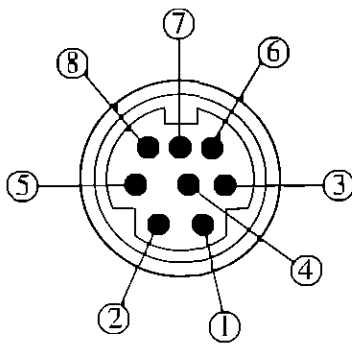

Pin No	Signal name	Contents
1	CTS	Clear to send
2	RTS	Request to send
3	RXD	Data input
4	GND	GND
5	TXD	Data output
6	DTR	Data terminal ready
7	NC	Spare
8	NC	Spare

2. Communication settings

Signal level	Determined by the RS-232C interface
Synchronizing method	Asynchronous
Baud rate	9600 bps
Parity	None
Character length	8 bits
Stop bit	1 bit
X parameter	None
S parameter	None

3. Basic format

Each packet which is sent from the computer starts with STX. Following this is the command itself and the parameters for that command (if any), and the packet then ends with ETX. Add parameters when necessary according to the control contents

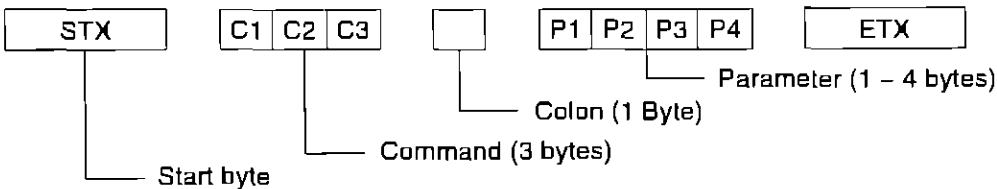

NOTE

- If sending multiple commands, check that a response has been received from the projector for one command before sending the next command

4. Table of commands

1) Control commands

Command	Control Contents	Remarks
PON	Power ON	In standby mode, all commands other than the PON command are ignored
POF	Power OFF	
RON	Remote control unit operation enabled	
ROF	Remote control unit operation disabled	
AUU	Volume UP	Parameter 000 = Adjustment value 0 ↓ 063 = Adjustment value 63
AUD	Volume DOWN	Parameter 000 = Adjustment value 0 ↑ 063 = Adjustment value 63
AMT	Mute	Parameter 0 = MUTE OFF 1 = MUTE ON
IIS	Input signal selection	Parameter VID = VIDEO RGB = RGB USR = RGB (USER)
OMN	Menu	
OCU	Cursor ^	
OCD	Cursor v	
OCL	Cursor <	
OCR	Cursor >	
OST	Standard	

Command	Control Contents	Remarks
OPO	Projection method setting	Parameter 0 = FRONT/FLOOR 1 = REAR/FLOOR 2 = FRONT/CEILING 3 = REAR/CEILING
OID	On-screen display of input signal	Parameter 0 = OFF 1 = ON
ORP	Power ON/OFF using remote control unit	Parameter 0 = OFF 1 = ON
VMD	Picture mode selection	Parameter 1 = MODE 1 3 = MODE 3
VCO	COLOR adjustment	Parameter -20 = Adjustment value -20 +00 = Adjustment value 0 +01 = Adjustment value +1 +20 = Adjustment value +20
VTN	TINT adjustment	Parameter -20 = Adjustment value -20 +00 = Adjustment value 0 +01 = Adjustment value +1 +20 = Adjustment value +20
VBR	BRIGHT adjustment	Parameter -10 = Adjustment value -10 +00 = Adjustment value 0 +01 = Adjustment value +1 +10 = Adjustment value +10
VCN	CONTRAST adjustment	Parameter -15 = Adjustment value -15 +00 = Adjustment value 0 +01 = Adjustment value +1 +15 = Adjustment value +15

Command	Control Contents	Remarks
VHL	H-BLANKING-LEFT correction	Parameter +00 = Adjustment value 0 +01 = Adjustment value +1 +40 = Adjustment value +40
VHR	H-BLANKING-RIGHT correction	Parameter +00 = Adjustment value 0 +01 = Adjustment value +1 +40 = Adjustment value +40
VVU	V-BLANKING-UPPER correction	Parameter +00 (+00) ^{×1} = Adjustment value 0 (0) ^{×1} +01 ↓ = Adjustment value +1 +40 (+01) ^{×1} = Adjustment value +40 (+1) ^{×1}
VVL	V-BLANKING-LOWER correction	Parameter +00 (+00) ^{×1} = Adjustment value 0 (0) ^{×1} +01 ↑ = Adjustment value +1 +40 (+01) ^{×1} = Adjustment value +40 (+1) ^{×1}
VKS	KEYSTONE adjustment	Parameter -20 = Adjustment value -20 +00 = Adjustment value +00 +01 = Adjustment value +01 +20 = Adjustment value +20

※1 Values for RGB input signals with a display resolution of other than 640 × 480 dots

2) Condition query commands

Command	Query Contents	Command	Query Contents
QPW	Power condition	QPL	Dot clock frequency setting condition
QIN	Input signal condition	QHP	H-POSITION adjustment condition
QAV	Volume level	QVP	V-POSITION adjustment condition
QVM	Mode setting condition	QHL	H-BLANKING-LEFT correction condition
QVC	COLOR level	QHR	H-BLANKING-RIGHT correction condition
QVT	TINT level	QVU	V-BLANKING-UPPER correction condition
QVB	BRIGHT level	QVL	V-BLANKING-LOWER correction condition
QVR	CONTRAST level	QKS	KEystone adjustment condition
QVS	SHARPNESS level	QSP	Projection method setting condition
QCT	COLOR TEMP level	QDI	INPUT DISPLAY condition
QCP	CLOCK PHASE level	QRP	Remote control unit power ON/OFF setting condition
QSG	Input signal setting mode condition		

<Responses sent to the computer for condition query commands>

The projector sends the following responses to the computer when a condition query command is received

<ul style="list-style-type: none"> Adjustment condition response 	Sends the adjustment level value	<ul style="list-style-type: none"> Input signal setting mode condition response 	AUT = AUTO MC3 = MAC 13"-67 Hz NTS = NTSC P98 = PC9801-56 Hz PAL = PAL VG7 = VESA-73 Hz SVD = S-VIDEO SV1 = SVGA-56 Hz VG4 = VGA 400-70 Hz SV2 = SVGA-60 Hz VGA = VGA 480-60 Hz US1 = USER 1 MC2 = MAC 12"-60 Hz US2 = USER 2
<ul style="list-style-type: none"> Mode setting response 	Sends the mode setting number	<ul style="list-style-type: none"> Input signal condition response 	VID = Video RGB = RGB USER = RGB (USER)
<ul style="list-style-type: none"> ON/OFF setting response 	0 = OFF 1 = ON		
<ul style="list-style-type: none"> Projection method setting response 	0 = front/floor 1 = rear/floor 2 = front/ceiling 3 = rear/ceiling		

Indicators

There are two indicators on the front operation panel of the projector which give information about the operating condition of the projector. These indicators illuminate or flash to warn you about problems that have occurred inside the projector, so if you notice that one of the indicators is on, turn off the power and check the table below for the cause of the problem.

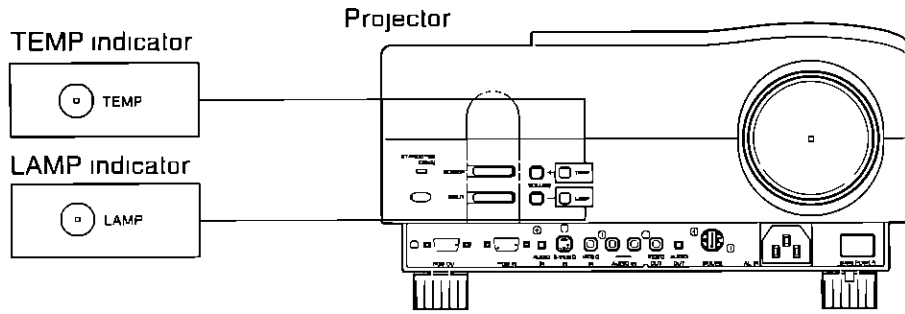

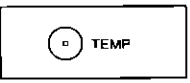
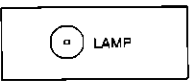
Indicator name	Indicator display	Problem	Possible cause	Remedy
TEMP indicator 	Illuminated (red)	The internal projector temperature is too high	The ventilation holes may be covered The ambient temperature in the place of use may be too high	Uncover the ventilation holes Set up the projector in a place where the temperature is between 41°F (5°C) and 104°F (40°C) and the humidity is between 10% and 80% (with no condensation)
		Flashing (red)	The metal halide lamp has turned off automatically because the internal temperature has risen to an abnormally high level	The air filter may be blocked
LAMP indicator 	Illuminated (red)	It is nearly time to replace the lamp unit	Does "LAMP" appear on the screen after the projector is turned on?	This occurs when the operation time for the lamp unit is nearing 1,000 hours. Ask your dealer or an Authorized Service Center to replace the lamp unit.
		Flashing (red)	The metal halide lamp switches off automatically	The power may have been turned on immediately after it was turned off There may be an abnormality in the lamp circuit

NOTE

- Be sure to turn off the main power by following the procedure given in "Turning the power on and off" on page 12 before carrying out any of the procedures in the "Remedy" column.

Cleaning the air filter

If the air filter becomes clogged with dust, the internal temperature of the projector will rise and the protection circuit will operate to switch the projector automatically to standby mode. The air filter should be cleaned at least once every 100 hours of projector use. Frequent cleaning of the air filter is particularly advised when using the projector in places where there is a lot of dust.

In addition, if the internal temperature rises, the temperature indicator will illuminate red before the projector is automatically switched to standby mode. Clean the air filter immediately if this happens.

Location of the air filter (bottom view)

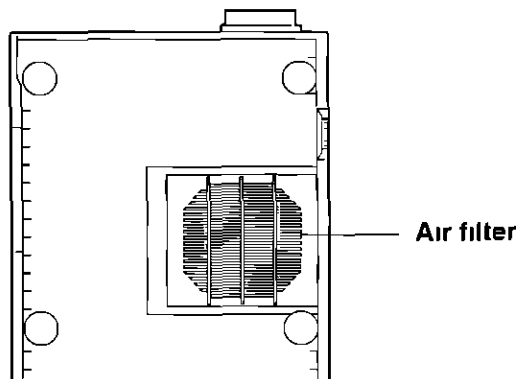

Air filter cleaning procedure

1 Turn off the main power supply according to the procedure given in "Turning the power on and off" on page 12.

2 Remove the air filter.

NOTE

- The air filter is integrated with the cover, so clean the filter without removing it from the cover.

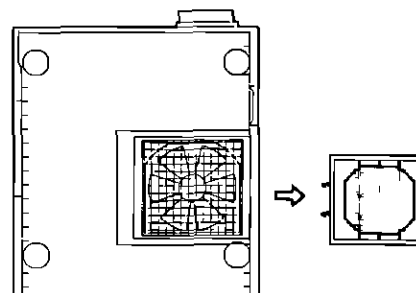

3 Use a vacuum cleaner to remove the dust from the air filter.

NOTE

- Do not pull the sponge lining off the frame of the air filter.

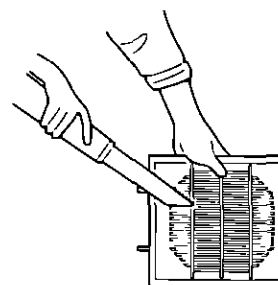

4 Slide the air filter back into its original position.

NOTE

- If the air filter is not inserted securely, the protection circuit will operate and you will not be able to turn on the projector power supply.
- If the air filter is still dirty even after you have tried to clean it, it should be replaced. Contact an Authorized Service Center to obtain a new air filter.

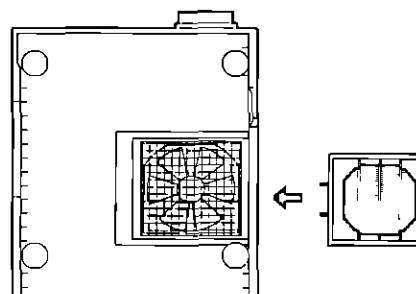

Lamp unit replacement period

The luminosity of the lamp unit will be reduced by about half after approximately 1,000 hours of use. This should be used as an indication that replacement of the lamp unit is necessary. If you continue to use the lamp unit after 1,000 hours of total usage time have passed, the following display will appear to avoid problems occurring through reaching the end of the useful life of the lamp unit.

• Display after 1,000 hours of use

When the usage time for the lamp unit reaches approximately 1,000 hours, the LAMP indicator will illuminate as a warning, even when the projector is in standby mode.

After this, an on-screen display such as the one shown at right will appear when the projector is turned on to indicate that replacement of the lamp unit is necessary.

This display will be cleared automatically after approximately 30 seconds.

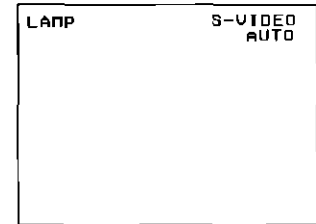

Replacing the lamp unit

Notes on replacing the lamp unit

- Because the lamp unit in this projector incorporates a metal halide lamp, the temperature inside the lamp rises during use and the lamp becomes very hot. After turning off the MAIN POWER switch and disconnecting the power cord from the wall socket, wait for the lamp to cool down before replacing the lamp unit.
- Take extreme care when handling the removed lamp unit, as it contains gas under high pressure and can easily become damaged if it is struck against hard objects or dropped.
- The old lamp unit may shatter if it is handled roughly after removal. Ask an authorized waste disposal agency to dispose of the old lamp unit.
- A Phillips screwdriver is necessary for removing the lamp unit. Make sure that your hands are not slippery when using the screwdriver.

NOTE

- The projector is not supplied with a replacement lamp unit. Please ask your dealer for details.
Lamp unit product no. ET-LA390

CAUTION Do not use any lamp unit other than the one with the product number indicated above.

Lamp unit replacement procedure

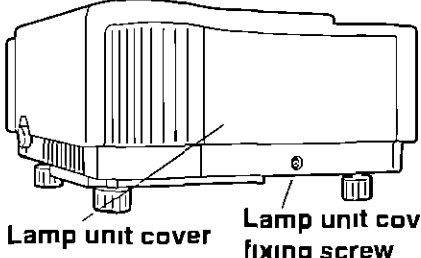
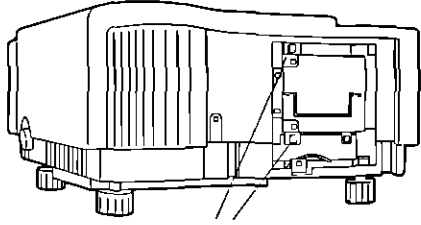
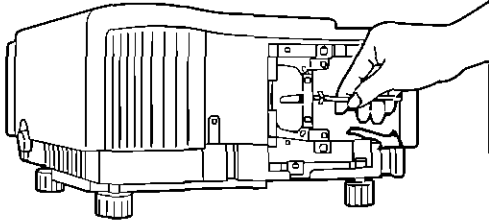
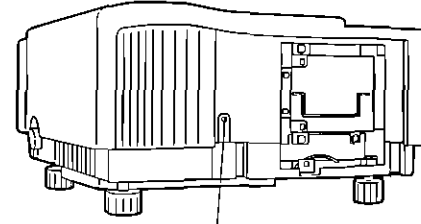
①	Disconnect the power cord from the wall socket and check that the lamp unit has cooled down	
②	<p>Use a Phillips screwdriver to remove the lamp unit cover fixing screw, and then remove the lamp unit cover from the projector</p> <p>NOTE</p> <ul style="list-style-type: none"> Take note of the warnings and cautions which are printed on the label on the lamp unit cover before removing the cover 	 <p>Lamp unit cover Lamp unit cover fixing screw</p>
③	<p>Use the Phillips screwdriver to remove the two screws which are securing the lamp unit</p> <p>NOTE.</p> <ul style="list-style-type: none"> Keep the screws in a safe place so that they do not get lost Do not use any screws other than the ones specified 	 <p>Lamp unit fixing screws</p>
④	<p>While holding the grip which is attached to the lamp unit, pull the lamp unit gently out from the projector</p> <p>CAUTION</p> <ul style="list-style-type: none"> The lamp unit will be hot immediately after it has been used, and you may receive severe burns if you touch it. Wait until the lamp unit has cooled down sufficiently before attempting to replace it 	
⑤	<p>Insert the new lamp unit into the projector, while making sure that the direction of insertion is correct, and then secure it with the two lamp unit fixing screws. Use the Phillips screwdriver to tighten the screws</p> <p>NOTE</p> <ul style="list-style-type: none"> Insert the lamp unit so that the lamp core can be seen at the left 	
⑥	Insert the power cord plug into the wall socket and turn on the MAIN POWER switch at the front of the projector	
⑦	Use an insulated screwdriver with a narrow tip to press the lamp cumulative time reset button which is inside the lamp unit cover continuously for three seconds or more. This will reset the lamp usage time to zero. The lamp indicator will switch off at the same time	 <p>Lamp cumulative time reset button</p>
⑧	Replace the lamp unit cover	

NOTE:

- Make sure that the lamp unit is installed securely. If the lamp unit or the lamp unit cover is not installed securely, the protection circuit may operate and the power will not turn on. If this happens, turn the MAIN POWER switch off and then on again.

Before asking for service, check the following points.

Problem	Possible cause
Power does not turn on	<ul style="list-style-type: none"> ■ The power cord is not connected ■ The main power switch on the projector is turned off ■ The main power supply is not being supplied to the wall outlet ■ TEMP indicator is illuminated or flashing Correct the problem while referring to the instructions on pages 39 and 40 ■ LAMP indicator is illuminated or flashing Correct the problem while referring to the instructions on page 39 ■ The air filter cover or lamp unit cover has not been correctly installed
No picture appears	<ul style="list-style-type: none"> ■ The lens cap may still be attached to the lens ■ The video signal input source may not be connected properly ■ The input selection setting may not be correct ■ The BRIGHT adjustment setting may be at the minimum possible setting
The picture is fuzzy	<ul style="list-style-type: none"> ■ The lens focus may not have been set correctly, or the projector may not be at the correct distance from the screen ■ The lens may be dirty ■ The projector may not be set up so that it is perpendicular to the screen
COLOR is too light or TINT is poor	<ul style="list-style-type: none"> ■ COLOR or TINT adjustment may be incorrect ■ The input source which is connected to the projector may not be adjusted correctly
No sound can be heard	<ul style="list-style-type: none"> ■ The audio signal source may not be connected properly ■ The volume adjustment may be at the lowest possible setting ■ The MUTE function may be active
Remote control unit does not operate	<ul style="list-style-type: none"> ■ The batteries may be spent, or they may not be inserted correctly ■ There may be an object between the remote control unit and the projector which is blocking the infrared signals ■ The remote control unit may be out of the operation range
The picture does not display correctly	<ul style="list-style-type: none"> ■ The correct input signal may not be selected ■ The input signal setting mode (SIGNAL MODE) may not be set correctly ■ There may be a problem with the VCR tape or other signal source

Specifications

Power supply	AC 100 – 240 V, 50/60 Hz
Power consumption	380 W (However, in remote control standby mode with the fan stopped, the projector still consumes the following amount of current For 100 – 120 V power supply 10 W For 220 – 240 V power supply 17 W)
Max amps	For 100-V power supply 4.0 A For 120-V power supply 3.5 A For 220-V power supply 1.8 A For 240-V power supply 1.7 A
LCD panel	Panel size 1.3
Display method	3 transparent LCD panels (RGB)
Drive method	Active matrix method
Resolution	921,600 pixels
Lens	Manual focus zoom lens (1 – 1.43) F 3.2 – 3.5 f 53.5 – 76.4
Lamp	Metal halide (250 W)
Brightness	350 lm/ANSI
Projection size	30 – 300 inches
Throw distance	5'3" – 40'8" (1.6 – 12.4 m)
Optical axis shift	1/1 – 1/9
Screen aspect ratio	4.3
Installation	CEILING/FLOOR/FRONT/REAR (Menu selection method)
Speaker	3 ⁵ / ₃₂ " (8 cm) round × 1 (monaural)
Max usable volume output	1.5 W (10% THD)
Connection terminals	
RGB IN connector	Single-line D-SUB HD 15-pin (female)
Dot clock frequency	32 MHz or less
R G B	0.7 Vp-p, 75 Ω
HD/SYNC	0.8 – 5.0 Vp-p high impedance, automatic plus/minus polarity compatible
VD	0.8 – 5.0 Vp-p high impedance, automatic plus/minus polarity compatible
AUDIO IN terminal for RGB	Single-line, M3 jack (Stereo MINI) × 1 0.5 Vrms
VIDEO IN terminal	Single-line, RCA pin jack (S-VIDEO priority) 1.0 Vp-p, 75 Ω, NTSC/PAL-compatible
S-VIDEO IN terminal	Single-line, Mini DIN 4-pin Y 1.0 Vp-p, C 0.286 Vp-p, 75 Ω, NTSC/PAL-compatible
AUDIO IN L–R terminals for S-VIDEO/VIDEO input	Single-line, RCA pin jack × 2 (L–R) 0.5 Vrms
RGB OUT connector	Single-line, D-SUB HD 15-pin (female)
R G B	0.7 Vp-p, 75 Ω
HD/SYNC	Pass-through from HD/SYNC terminal of RGB IN connector
VD	Pass-through from VD terminal of RGB IN connector
VIDEO OUT terminal	Single-line, RCA pin jack 1.0 Vp-p, 75 Ω termination
AUDIO OUT terminal	Single-line, M3 jack (Stereo MINI) × 1 (monitoring output and stereo compatible) 0.5 Vrms

Connection terminals	
RS-232C input connector	8-pin mini DIN connector For computer-controlled operation
MOUSE input connector	13-pin round connector For infrared mouse operation (PS/2, Macintosh and serial computer compatible)
Power cord length	8'2" (2.5 m)
Dimensions	
Width	13 ³ / ₈ " (340 mm)
Height	7 ¹³ / ₃₂ " (188 mm)
Length	15 ³ / ₁₆ " (386 mm) (not including lens extension length)
Weight	22.9 lbs (10.4 kg)
Operating environment	
Temperature	41°F – 104°F (5 – 40°C)
Humidity	10 – 80% (no condensation)
Certifications	UL1410, C-UL FCC
<Remote control unit>	
Power supply	3 V DC (two AA-size batteries)
Operation range	49'3" (Approx. 15 m) (When operated from directly in front of the signal receptor)
Weight	0.218 lbs (Approx. 99 g) (with batteries)
Dimensions	
Width	1 ¹³ / ₁₆ " (46 mm)
Height	1 ¹¹ / ₃₂ " (34 mm)
Length	7 ³ / ₃₂ " (180 mm)
Accessories	
Remote control unit	1
AA-size batteries	2
Power cord	1
VGA cable	1 (4'11" [1.5 m], D-SUB HD 15-pin [male] ↔ D-SUB HD 15-pin [female])
VGA/Macintosh adapter	1 (D-SUB HD 15-pin [female] ↔ D-SUB 15-pin [male])
Computer sound cable	1 (4'11" [1.5 m], M3 stereo mini plug)
AV cable	1 (4'11" [1.5 m], RCA pin × 3)
BNC/RCA adapter	1 (RCA pin [male] ↔ BNC [female])
PS/2 mouse cable	1 (4'11" [1.5 m], 13-pin round [male] ↔ DIN 6-pin [male])
Macintosh mouse cable	1 (4'11" [1.5 m], 13-pin round [male] ↔ DIN 4-pin [male])
Serial mouse cable	1 (4'11" [1.5 m], 13-pin round [male] ↔ D-SUB 9-pin [female])
Optional accessories	CEILING MOUNT BRACKET ET-PK390L

- Design and specifications are subject to change without notice
Weight and dimensions shown are approximate

External dimensions

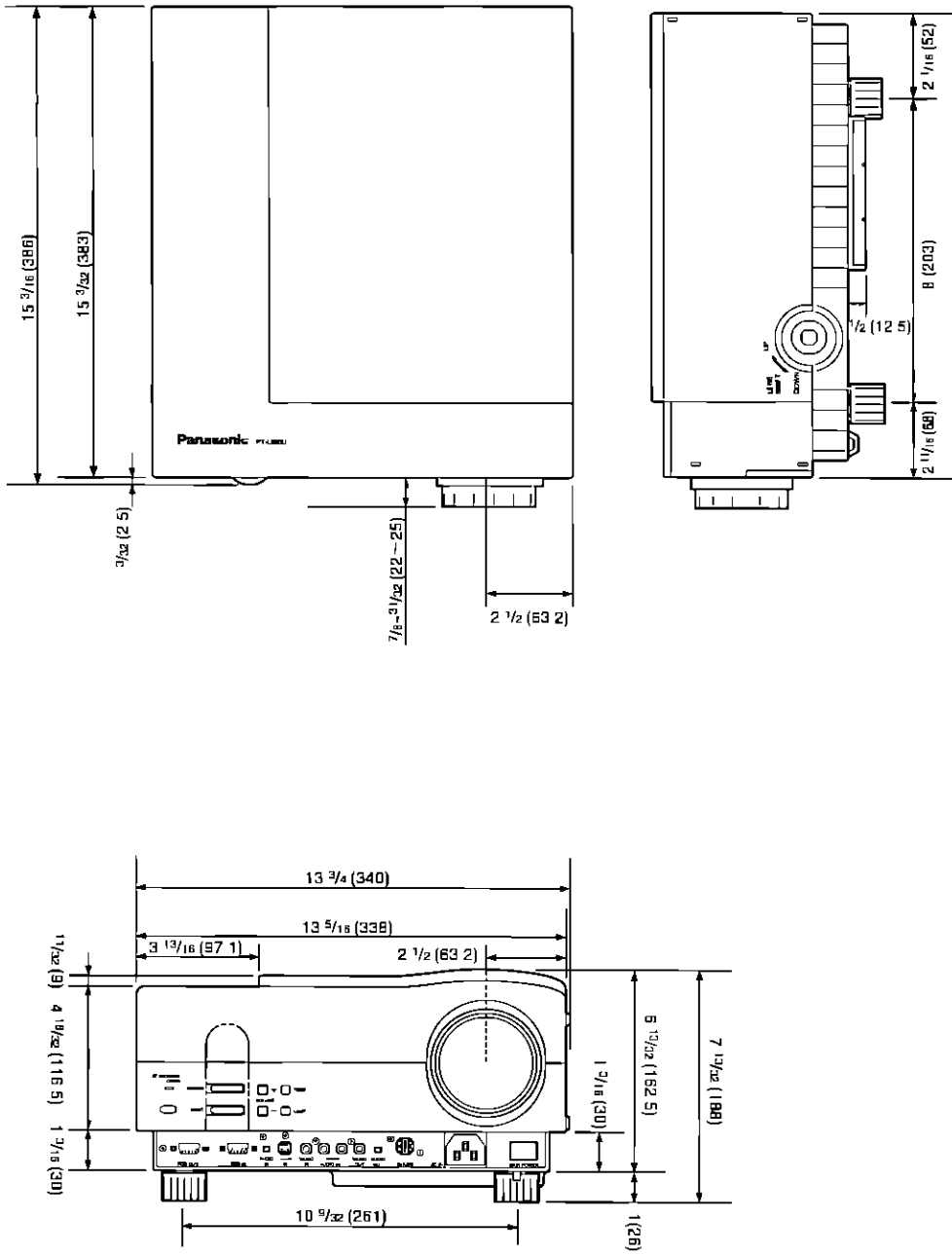

UNIT inch (mm)

Panasonic[®]

Professional/Industrial Video

Panasonic Broadcast & Television Systems Company
Division of Matsushita Electric Corporation of America

Executive Office:

One Panasonic Way (3F-5) Secaucus, New Jersey 07094

EASTERN ZONE:

43 Hartz Way, Secaucus, NJ 07094 (201) 348-7620

CENTRAL ZONE:

1707 N Randall Rd, Elgin, IL 60123 (708) 468-5200

SOUTHERN ZONE

Dallas Region 4500 Amon Carter Blvd, Fort Worth, TX 76155 (817) 685-1117

Atlanta Region 1225 Northbrook Parkway, Suite 170, Suwanee, GA 30174 (404) 338-6855

WESTERN ZONE

Los Angeles Region 6550 Katella Ave, Cypress, CA 90630 (714) 373-7275

Government Marketing Department 52 West Gude Drive, Rockville, MD 20850 (301) 738-3840

Matsushita Electric Corporation of America

Corporate Sales Group, Hawaii Region

99-859 Iwaiwa ST, Aiea, HI 96701-3267 (808) 488-7779

Matsushita Electric of Canada Limited

5770 Ambler Drive, Mississauga, Ontario L4W 2T3 (905) 624-5010

Panasonic Sales Company

Division of Matsushita Electric of Puerto Rico, Inc.

San Gabriel Industrial Park, 65th Infantry Ave, K M 9 5, Carolina, PR 00630 (809) 750-4300